



ICV Operation Manual Ventilator

Table of Contents

Table of Contents.....	I
Product information	VII
Intellectual property rights.....	VIII
Statement.....	IX
Maintenance service.....	IX
Guarantee	X
After-sales service unit	X
Return	X
Important information.....	X
1. Safety instructions	1
1.1. Overview	1
1.2. Safe use of oxygen	2
1.3. Ventilation/operation	3
1.4. Patient ventilation line components.....	3
1.5. Software	4
1.6. Accessories/spare parts.....	4
1.7. Battery	4
1.8. Description of symbols.....	5
2. Device Overview.....	7
2.1. Intended use	7
2.2. Contraindications	7
2.3. Intended operating environment.....	7
2.4. User qualification	7
2.5. Product description	7
2.6. Appearance description	8
2.6.1. Mainframe - front view.....	8
2.6.2. Mainframe - rear view.....	10
2.6.3. Mainframe - left view	12
2.6.4. Mainframe – right view	13
2.6.5. ICV component diagram	14
3. Installation	15
3.1. Packing items.....	15
3.2. Installation of battery.....	15

3.3. Connection of oxygen source	16
3.4. Power supply connection.....	17
3.4.1. Connect AC power supply	17
3.4.2. Connect DC power supply	17
3.5. Install the mainframe	18
3.6. Install support arm	19
3.7. Patient respiratory line assembly and its connection.....	19
3.8. Install humidifier	21
3.9. Infant invasive pipeline connection	22
3.10. Infant noninvasive pipeline connection	23
3.11. Install nebulization.....	24
3.12. Install EtCO ₂	24
3.13. Patient breathe valve	25
3.13.1. Patient inspiratory valve	25
3.13.2. Patient expiratory valve	25
4. Interface description	27
4.1. Main interface components	27
4.2. Waveform interface.....	29
4.2.1. Respiration Parameters switching	29
4.2.2. Monitor Parameters switching.....	29
4.2.3. Monitor waveform switching.....	30
4.3. Loops interface	30
4.4. Monitoring value interface	31
4.5. Trend Chart interface	31
4.6. Mechanics interface.....	32
4.7. Freeze	32
4.8. Events	32
4.9. Settings	33
4.9.1. System.....	33
4.9.2. General	35
4.9.3. Maintenance	35
4.9.4. About.....	36
5. Special functions	37
5.1. Lung recruitment maneuver(RM)	37
5.2. CPR.....	37
5.3. PEEPi	38

5.4. P0.1	38
5.5. NIF	38
5.6. Dynamic lung	39
5.7. Suction	39
5.8. Insp. holding.....	40
5.9. Exp.holding	40
5.10. Manual.....	41
5.11. Nebulization.....	41
5.12. P-V tool.....	42
6. Alarm	43
6.1. Alarm message	43
6.2. Alarm priority	43
6.3. Technical Alarm	44
6.4. Physiological alarm.....	47
6.5. Battery alarms	48
6.6. Communication Alarms.....	49
6.7. Alarm rules	49
6.8. Alarm mode	50
6.9. Setting of alarm limits	51
6.10. Alarm parameter range	51
7. Operations.....	54
7.1. Power-on.....	54
7.2. Self check and calibration.....	54
7.3. Select the patient	55
7.4. Ventilation type.....	57
7.4.1. Invasive ventilation(IV)	57
7.4.2. Non-invasive ventilation(NIV).....	57
7.5. Selecting ventilation mode.....	57
7.6. Ventilation settings.....	58
7.6.1. Ventilation parameter setting.....	58
7.6.2. Ventilation parameters in each mode	59
7.6.3. IPPV and PCV	61
7.6.4. V-A/C and P-A/C.....	62
7.6.5. V-SIMV and P-SIMV	63
7.6.6. CPAP/PSV	64
7.6.7. BiPPV bilevel positive airway pressure.....	64

7.6.8. APRV	65
7.6.9. PRVC	66
7.6.10. PRVC-SIMV	66
7.6.11. CPAP	67
7.6.12. HFNC	67
7.6.13. Apnea ventilation	68
7.6.14. Sigh	68
7.6.15. Intubation/Automatic tube compensation	69
7.6.16. Compliance compensation	69
7.7. Standby	69
7.8. End ventilation	70
7.9. Oxygen consumption	70
7.9.1. Oxygen consumption	70
7.9.2. Oxygen consumption zeroing	71
7.10. Data Export	71
8. CO2 monitoring	72
8.1. Overview	72
8.2. CO ₂ monitoring setting	73
8.3. Measurement influencing factors	73
8.4. EtCO ₂ zero calibration	73
9. Cleaning and disinfection	74
9.1. ICV mainframe	74
9.2. Respiratory line components	74
9.3. Parts and accessories	74
9.4. Valve accessories	75
9.5. Replacement of filter cotton	75
9.6. Handling method	76
10. Faults and troubleshooting methods	78
10.1. Technical faults	78
10.2. Physiological alarm	78
10.3. System alarms	79
10.4. Abnormal power failure alarms	80
11. Maintenance and inspection	81
11.1. Routine inspections	81
11.2. Check air tightness of the system	81
11.3. Check patient respiratory valve	82

11.4. Functional inspection of machine	82
11.5. Touch screen calibration	84
11.6. Oxygen concentration calibration	84
11.7. Flow sensor calibration	85
11.8. Hose compliance.....	85
11.9. Hose resistance	85
11.10. Gas line zero calibration	86
11.11. Gas line self-check.....	86
11.12. Battery management.....	86
11.12.1. Battery inspection	86
11.12.2. Battery storage	87
11.12.3. Battery replacement	87
11.12.4. Battery status description	88
11.13. Accessories	89
11.14. Storage	89
11.15. Disposal of abandoned device	89
12. ICV accessories.....	90
13. Product specifications	91
13.1. Safety specifications	91
13.2. Physical specifications.....	91
13.3. Environmental specifications.....	92
13.4. Power supply specifications	92
13.5. Gas supply specifications	93
13.6. Parameter specification	94
13.7. CO ₂ specifications	97
13.8. Gas line diagram.....	97
13.9. Parts list.....	97
13.10. Principle Description	98
14. EMC	100
14.1. Electromagnetic radiation declaration	100
14.2. Battery immunity declaration - requirements for all devices and systems	101
14.3. Guidelines and manufacturer's statement - electromagnetic immunity	103
14.4. Recommended isolation distance	105
14.5. Basic EMC performance of ICV ventilator	106
15. Product warranty	107

16. Classification details of toxic and harmful substances	108
17. Storage and transportation	110

Product information

Thank you for purchasing the ICV ventilator.

To use this device correctly, please read and understand the contents of this Operation manual carefully before use. After reading, keep this manual at a proper place where it is easy to access.

Product Name: Ventilator

Model: ICV

Manufacturer name: Gradian Health Systems

Manufacturer address: 40 W 25th St., 6th Floor, New York, NY 10010, USA

Manufacturing Date: See the mainframe

Usage period: 8 years

Revision date: 08-2022

Version: 1.0



Notices: This instrument is not designed for household purposes.

Intellectual property rights

©2022 Gradian Health Systems, All rights reserved

The intellectual property rights of this product and its Operation Manual belongs to Gradian Health Systems, including but not limited to the patent right, trademark right, and copyright, etc.

Gradian Health Systems reserves the right for final interpretation of this Operation Manual.

Gradian Health Systems reserves the right to treat this Operation Manual as confidential information. Without written permission of Gradian Health Systems, no individual or organization shall disclose all or part of the information of this Operation Manual by any means, nor allow others or organizations to obtain all or part of the information of this Operation Manual by any means.

Without written permission of Gradian Health Systems, no individual or organization shall publish, modify, copy, distribute, rent, adapt or translate all or part of this Operation Manual into other languages.

 is the registered trademark or trademark of Gradian Health Systems. These trademarks and related Gradian Health Systems marks are the intangible property of Gradian Health Systems. The use of trademarks or logo other than those of Gradian Health Systems in this manual is only for editing and has no other purpose. Their rights belong to their respective rights owners.

Statement

Gradian Health Systems reserves the right to modify contents of this Manual without prior notice.

Gradian Health Systems reserves the right to change the technology without prior notice.

Gradian Health Systems reserves the right to modify the product specifications without prior notice.

Gradian Health Systems makes no guarantee of any kind with respect to this information material, including (but not limited to) its implied guarantee of marketability and suitability for a specific purpose.

Unless otherwise specified, "the Company" in this Operation Manual refer to Gradian Health Systems

The product pictures in this instruction manual are for reference only and are not exactly the same as the actual product, everything is subject to the actual product.

Gradian Health Systems considers itself responsible only for the safety, reliability and performance of the instrument under the following circumstances:

- Assembly operation, expansion, readjustment, improvement and repair which are carried out by the personnel approved by Gradian Health Systems
- The relevant electrical equipment meets the national standards;
- The instrument is operated in accordance with the operation instructions.
- Gradian Health Systems will not be responsible for safety, reliability and operating conditions of the product if:
 - Any component is disassembled, stretched, or readjusted;
 - The instrument is repaired or modified by the personnel not authorized by Gradian Health Systems;
 - The product is not operated correctly according to the Operation Manual.

Maintenance service

Free maintenance range:

- All devices in line with warranty service regulations of Gradian Health Systems can enjoy free service.

Charged maintenance range:

- Any equipment beyond the range of warranty services regulations of Gradian Health Systems will be charged by Gradian Health Systems for services;

- Within the warranty period, no warranty shall be granted under the following circumstances:

-
1. Man-made damages;
 2. Improper use;
 3. Power grid voltage exceeds the specified range of equipment;
 4. Irresistible natural disasters;

5. The machine is replaced with the parts and consumables that are not approved by the Gradian Health Systems, or the machine is repaired by the personnel not authorized by the Gradian Health Systems



Warning:

If the hospital or institution responsible for use of the instrument does not implement a satisfactory repair/maintenance plan, it may result in abnormal instrument failure and may endanger human health.

Guarantee

Manufacturing process and raw materials:

Gradian Health Systems guarantees that the instrument will have no production process or raw material fault during the warranty period under normal use and maintenance.

After-sales service unit

After-sales service department of Gradian Health Systems

Address: 40 W 25th St., 6th Floor, New York, NY 10010, USA

Tel: +1 917 396 7030

Website: www.gradianhealth.org

Return

Return procedures

Please follow the following steps if you do need to return the goods to Gradian Health Systems:

- Obtain the right of return: Contact the after-sales service department of Gradian Health Systems to inform serial number of the product, which has been marked on the outer packing box. If the serial number is not clearly identifiable, the return will not be accepted. Please specify the product model and briefly describe the reason for return.
- Freight: the user shall bear the freight (including customs charges) when the instrument is transported to Gradian Health Systems for repair.

Important information

1. After purchasing this product, the customer is fully responsible for maintenance and management of the product.

2. Even during the quality warranty period, the following conditions are not covered by the quality warranty:

- Damage or loss caused by wrong or rough use;
- Damage or loss caused by force majeure, such as fire, earthquake, flood or lightning.
- Damage or loss caused by failure to meet the specified operating conditions of the system, such as insufficient power supply, incorrect installation or non-conforming environmental conditions.
- Damage or loss caused by not operating the system in the area where the system is initially purchased.
- Damage or loss caused by the system which is not purchased from Gadian Health Systems or its authorized dealers or agents.

3. The equipment can only be operated by qualified medical personnel with professional qualification certificate.

4. Software or hardware or any other parts of the product are forbidden to be modified without authorization.

5. Gadian Health Systems shall not be responsible for any problems, damage or loss arising from the re-installation, modification or repair of the system by the personnel not designated by Gadian Health Systems.

6. This system is designed to provide doctors with the auxiliary tools needed for clinical treatment.

7. The doctors are responsible for the course of treatment. Gadian Health Systems has no responsibility for the course of treatment.

8. Important data should always be backed up to external storage media, such as clinical records, notebooks, etc.

9. Gadian Health Systems shall not be held responsible for the loss of data stored in the system due to operator error or abnormal circumstances.

10. This Operation Manual contains warnings about potential hazards that can be foreseen. Unstated dangers shall be kept on high alert at all times. Gadian Health Systems shall not be responsible for any damage or loss caused by negligence or disregard of the preventive measures specified in this Operation Manual.

11. This Operation Manual must be handed over whenever a system administrator changes.

1. Safety instructions

Please read these safety instructions carefully. These safety instructions are an integral part of the equipment and must be accessible at all times. For the sake of safety, please note the followings.

The safety instructions are marked in this Operation Manual as follows:



Warning:

Make a warning for the conditions that may cause a risk of harm to patients and users.



Caution:

Warn about the conditions that can cause equipment damage and may have incorrect treatment effects.



Hint:

Information alerts based on the contents of this user instruction.

1.1. Overview



Warning:

- A functional check must be performed before using this equipment (see "11 Maintenance and Inspection").
- Follow the instructions in "9 Cleaning and Disinfection" to prevent infection or bacterial infection.
- ICV can only be used after getting the proper medical training and technical guidance on ventilator usage as improper use may lead to death of the patient.
- It is strictly forbidden to leave the patient or the ventilator during ventilation, so as to make timely response to emergencies (such as deterioration of the patient's condition or machine failure), and to minimize the patient's injury.
- ICV may only be used for the specified purposes (see "2.1 Intended use").
- ICV is strictly prohibited in high-pressure applications (hyperbaric chamber).
- The use of ICV is strictly prohibited in explosive or toxic environments.
- The use of ICV is strictly prohibited in oxygen-rich or flammable environments.
- The device is not intended for use in a magnetic resonance imaging (MRI) environment.
- Use of antistatic or conductive masks or ventilator lines when using high-frequency surgical equipment may cause burns, so do not use antistatic/conductive

masks or ventilator lines.

- This equipment cannot be used with nitric oxide.
- This equipment cannot be used with helium or mixtures containing helium.
- In case of ventilator failure, if other ventilation methods cannot be applied immediately, it may result in patient death.
- Non-maintenance personnel are prohibited to open the ICV cover to change or replace any external or internal parts of ICV.



Caution:

- When ICV is used together with devices that emit high-frequency radiation (e.g. mobile phones, radios), a distance of more than 1m must be maintained, otherwise it may cause dysfunction.
- When an external power supply is used to supply power to ICV, always connect it to an easily pluggable interface so that it can be quickly unplugged in case of failure.
- When an external power supply is used to supply power for ICV, ensure that the power cord does not form an obstruction. Please do not use the external power supply when it is not necessary (i.e., battery power is less than 20% or the battery power is used uninterruptedly for a long time). Battery power is preferred.
- To avoid the risk of electric shock, this device should only be connected to an electrical outlet with a protective earth ground. Do not use the outlet if it is not connected to an earth conductor.
- Do not open the housing of the device, otherwise there may be a risk of electric shock. Repairs or upgrades to the equipment should only be performed by service personnel trained and authorized by the Company.
- If the external protective conductors in the installation or its integrity of wiring is in doubt, the device should be operated by the internal battery.
- An alternative backup ventilator must be available in case of equipment failure.
- If the device is used in dirty environment, the filter should be replaced as described in "9.5 Replace of filter cotton".
- Do not immerse ICV in any liquid. If any liquid gets into the cover, it can cause damage to the device.

1.2. Safe use of oxygen



Warning:

- When the high-pressure oxygen meets with any combustibles (grease, oil, and

alcohol, etc.)it can cause explosion.

- Long-term supply of high-concentration oxygen to the patient can have toxic effects.The endurance of patients will vary due to their age and physical conditions. Please use appropriate ventilation method according to patient's condition.

- The device and all joints shall be kept clean, and no oil or grease is allowed.
- Please wear clean medical gloves before operating the oxygen supply unit.
- No smoking or open flame is allowed near the device and related supporting facilities.



Caution:

- When installing and replacing oxygen cylinders, please manually tighten relevant knob switches on oxygen cylinders and pressure reducing valves. It is strictly prohibited to use any tools, so as not to damage the thread and sealing material due to excessive force, resulting in leakage.

- Please take measures to prevent dumping of oxygen cylinders. The dumping of oxygen cylinders would cause damage of the pressure reducing valve or oxygen valve, or even cause an explosion.

- The valve of the cylinders shall be opened slowly. Opening the valve too aggressively and too quickly will cause a sudden rise in pressure, which will impact the valve fittings and cause damage.

- The oxygen cylinders shall not be completely used up to avoid corrosion of cylinders caused by intrusion of moist air in surrounding environment.

1.3. Ventilation/operation

- The patient and ventilator must be continuously observed during ventilation.
- Prolonged reliance on ICV for breathing may cause respiratory muscles of the patient to atrophy.
- Ventilation for a long time can dry out the respiratory tract.
- Ensure that the patient breathing tube and inspiratory end are connected smoothly, otherwise the ventilation function of the equipment may be affected.
- The ventilator should not be placed next to a barrier as this will impede the flow of cold air and cause the device to overheat.

1.4. Patient ventilation line components



Warning:

- Professional medical training and technical guidance on the ventilator usage must be provided during use of the patient ventilation line assembly, as improper use may result in serious physical injury.

- Before use, please refer to the relevant contents in the manual for functional and visual inspection of the ventilation line components.

- Before connecting it with the patient, check that flow direction of the oxygen provided to the patient is correct and the ventilation line is smooth.

- The patient's ventilation line components can only be used for the specified purposes.

- The patient ventilator line components are not suitable for high-pressure applications (e.g. hyperbaric chamber).

1.5. Software

Extensive quality assurance measures have been taken during development of device software, so the risk arising from software defects is minimal.

Software version:V1.

1.6. Accessories/spare parts



Notices:

- [Prevention of exposure] Measures shall be taken to protect silicone and rubber parts from being exposed to ultraviolet light and long hours of direct sunlight, which would otherwise cause brittleness of these parts.

- [Only use the approved accessories] Using accessories from other manufacturers may cause malfunctions due to incompatibility. Please remember that the rights and obligations of the warranty will expire if: do not use the accessories recommended in the Operation Manual or do not use the original spare parts.

1.7. Battery



Warning:

[Low battery power] In case of low battery power alarm, please do any of the followings:

- Replace the battery with a fully charged battery.
- Connect the external power supply of ICV.



























Caution:





[Maintaining of battery installation] In order to enable continuous operation of ICV, it is

recommended to use a fully charged battery for the whole time (even when an external power supply is connected to supply power).

1.8. Description of symbols

The symbols used on this device or in this Manual are described in following table.

Symbol	Description	Symbol	Description
	Caution, please refer to attached documents		Refer to the Operation Manual
	Manufacturing Date		BF type application part
	Equipotential	IPX3	Protection level
	Do not discard in an ordinary trash bin		Power cord disconnection
	Refer to the manual provided with the device together/Operation Manual		On/Off switch of main unit
	AC power supply		Battery power supply
	Clearing alarms other than Advanced Alarms		Nebulization
	Function menu		Lock/unlock
	Muted alarm		Inspiratory interface
	Expiratory interface		USB port
	Oxygen inlet		Battery capacity state
	Non-invasive		Invasive
	Adult		Pediatric

	Infant		Patient trigger
	<p>The product contains some harmful substances, so it can be safely used within the environment-friendly use period, but it shall be put into recycling system after exceeding the environment-friendly use period. The product has an environment-friendly service life of 20 years.</p>		
	<p>It is in compliance with the European Union Medical Devices Directive 2007/47/EC, and meets the basic requirements for CE mark in Annex I of the Directive.</p>		

2. Device Overview

2.1. Intended use

This product is intended to be used in an intensive care environment within a professional medical institution, or for transportation within or outside a professional medical institution. It is used for ventilation assistance and respiratory support for adults, children and infants.

The ICV may be operated only if it is safely installed and fixed or placed on a licensed carrier platform. The product shall be operated by trained and authorized medical personnel.



Warning:

The ventilator shall not be covered or placed in a position that affects operation and performance of the ventilator.

2.2. Contraindications

The patients with pulmonary bullae, pneumothorax, macro hemoptysis, active tuberculosis, bronchopleural fistula, massive pleural effusion, acute myocardial infarction or other diseases, or the patients who cannot use the ventilator according to clinical experiences.

2.3. Intended operating environment

ICU, EICU, NICU, recovery room, operating room, intra-hospital and inter-hospital emergency transport, etc.

2.4. User qualification

The personnel operating ICV must meet the following conditions:

- This product should be operated by trained and authorized medical personnel.
- Has received the training on clinical application of ICV approved by Gradian Health Systems

Improper use may cause serious injury to personnel (operators and patients).

2.5. Product description

Main components of the ICV ventilator include:

Mainframe (including gas line, electronic system, mechanical structure, display, and carbon dioxide module), trolley, and support arm.

Gradian Health Systems has designed all components required for the ICV ventilation system.

2.6. Appearance description

2.6.1. Mainframe - front view

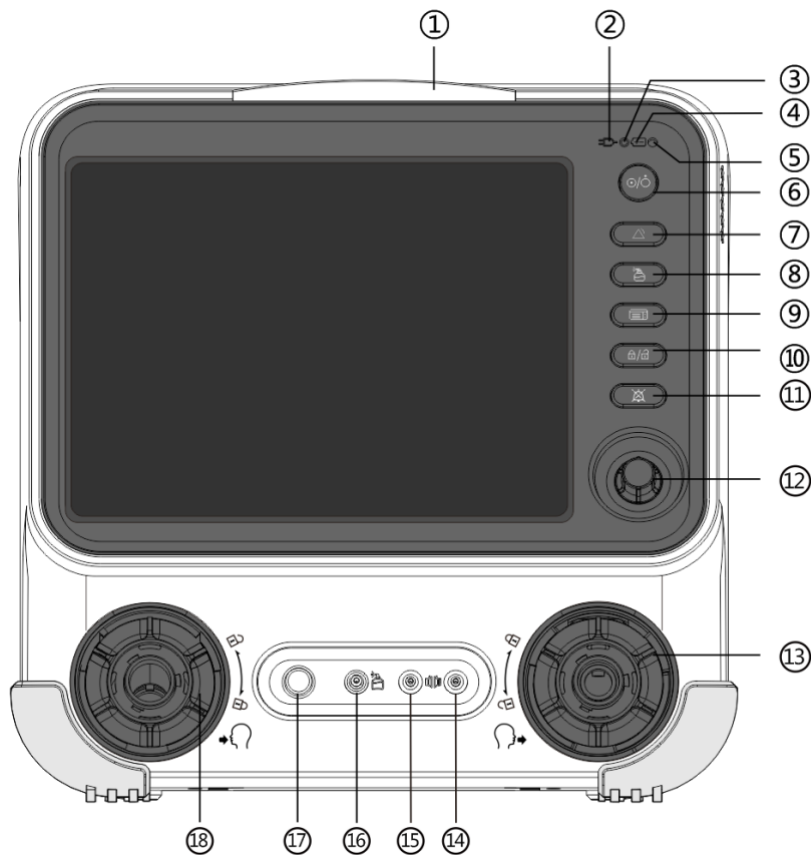

Fig. 2-1 Mainframe (front view)

Components	Description
1 Alarm light	In case of an alarm, the display turns into red, yellow flashing, the yellow remains on for a long time, indicating different priority level of alarm (red=high priority, yellow=medium/low priority level, off=no alarm)
2 External power supply sign	It indicates an external power indicator.
3 External power supply indicator	The indicator will remain on until the power cord is connected. Hint: When the ventilator is switched from the external power supply to internal power supply, the ventilator still works normally.

Components	Description
4 Battery sign	Battery indicator.
5 Battery indicator	The indicator will flash during charge, and will stay on until the battery is fully charged or in use. Tip: To indicate the ventilator is powered by an internal battery or an external power supply during operation.
6 On/off key	If it is in the shutdown state, click this button to turn on. If it is in standby state, click this key to pop up the shutdown confirmation interface, in this interface click [Yes] to shutdown, power on the running state long press 5 s to force shutdown.
7 Alarm cancel button	Press this button to clear all alarms other than advanced alarms.
8 Nebulization button	Press this button to turn the nebulization function on or off.
9 Main menu button	Used to bring up the main menu. It contains the settings such as "Time", "System", "Calibration", "Alarms", "Records", "About the machine" and other settings. The repeated operations will close the main menu
10 Screen lock button	It is used to lock the touch screen. If this button is pressed when the touch screen is active, the touch screen will be inactive and vice versa.
11 Alarm Mute button	This button can be used to turn off the voice alarm function for a period of time (up to 120 seconds); When the alarm is muted, the indicator next to this button will be lit. But the visual alarms (e.g. the warning lights and information bars flash) will not be turned off.
12 Navigation	It is used to operate the display interface, as described below: Press the knob to enter the selected page or select the selected item or save the settings; rotate the knob to adjust the selected item. Rotate it clockwise, to increase the selected setting parameter, and rotate anticlockwise to decrease the selected setting

Components	Description
	parameter.
13 Expiratory branch	It is used to connect the expiratory line and is provided with an expiratory valve.
14 External flow sensor interface	External flow sensor interface blue tube.
15 External flow sensor interface	External flow sensor interface white tube.
16 Nebulizer interface	Used to connect the nebulizer.
17 Leak test plug	Used to calibrate compliance
18 Inspiratory branch	Used to connect the inspiratory line.

2.6.2. Mainframe - rear view

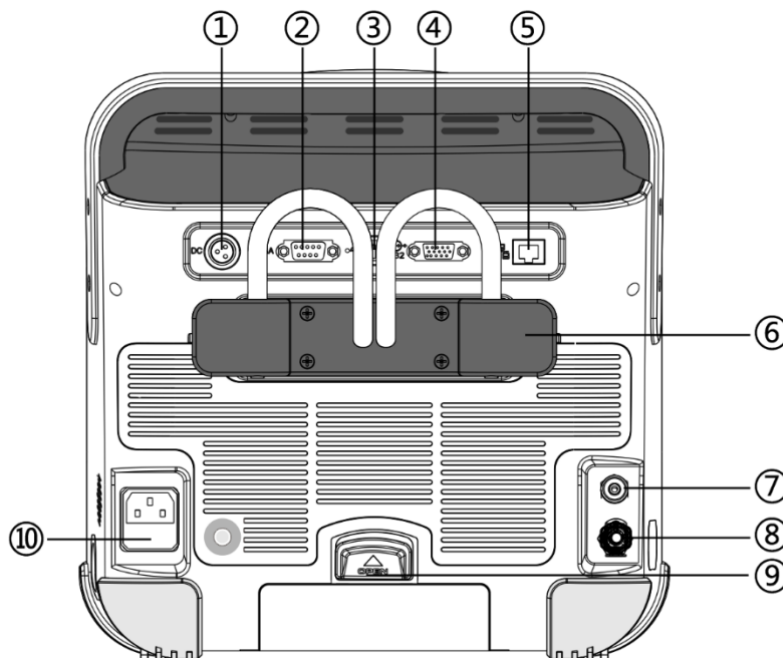

Fig. 2-2 Mainframe (rear view)

Components	Description
1 DC power input	Used to connect to the vehicle power supply.

Components	Description
port	
2 RS232 port	Used to connect to the external calibration equipment, or connect to medical grade external equipments.
3 USB port	You can upgrade the ventilator software through the USB port, or export configuration information and history data through the USB port (e.g., trend data, logs, etc.)
4 VGA port	Output the same VGA video signal as the main monitor display.
5 Network port	Provide support in connecting to PC for software upgrade.
6 Hook	Hook width: 45mm.
7 Gas supply port(high pressure)	Connect to high pressure gas supply.
8 Gas supply port(low pressure) 用于连接外部校准设备，活可以连接医疗级外部设备。	Connect to low pressure gas supply.
9 Battery latch 支持与 PC 机相连实现软件升级功能。	Used to remove and replace the rechargeable built in battery directly from downside.
10 AC power input socket 输出和主显示器显示内容相同 VGA 视频信号。	Used to connect to AC power.

2.6.3. Mainframe - left view

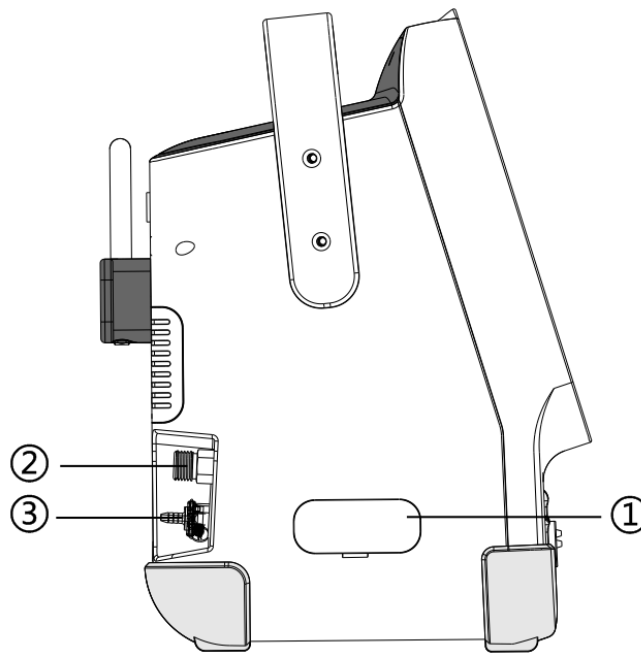

Fig. 2-3 Mainframe (left view)

Components	Description
1 EtCO₂ interface	It is visible after lifting the silicone cover and is used to connect the ETCO ₂ module.
2 Oxygen source interface (high pressure)	Used to connect the high-pressure oxygen source.
3 Oxygen source interface (low pressure)	Used to connect the low-pressure oxygen source.

2.6.4. Mainframe – right view

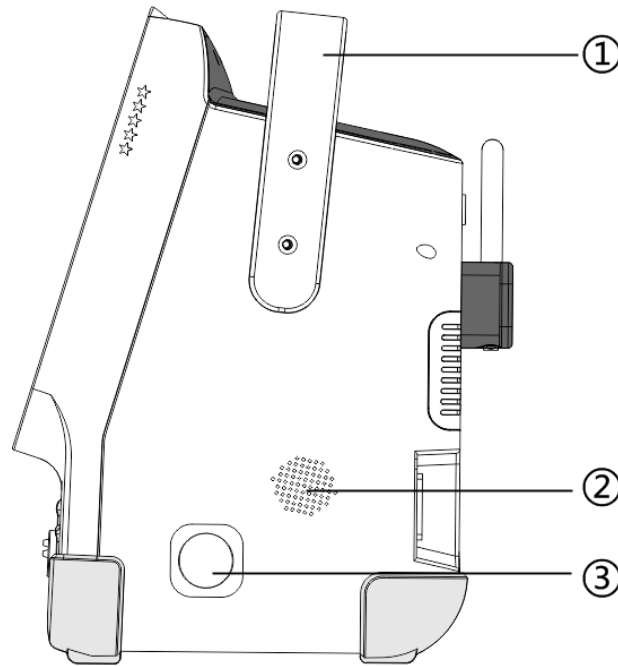

Fig. 2-4 Mainframe (right view)

Components	Description
1 Handle	Handle height: 27mm.
2 Speaker	Speaker of alarms, hints and alarms.
3 Exhalation valve exhaust	Used to discharge gas.

2.6.5.ICV component diagram

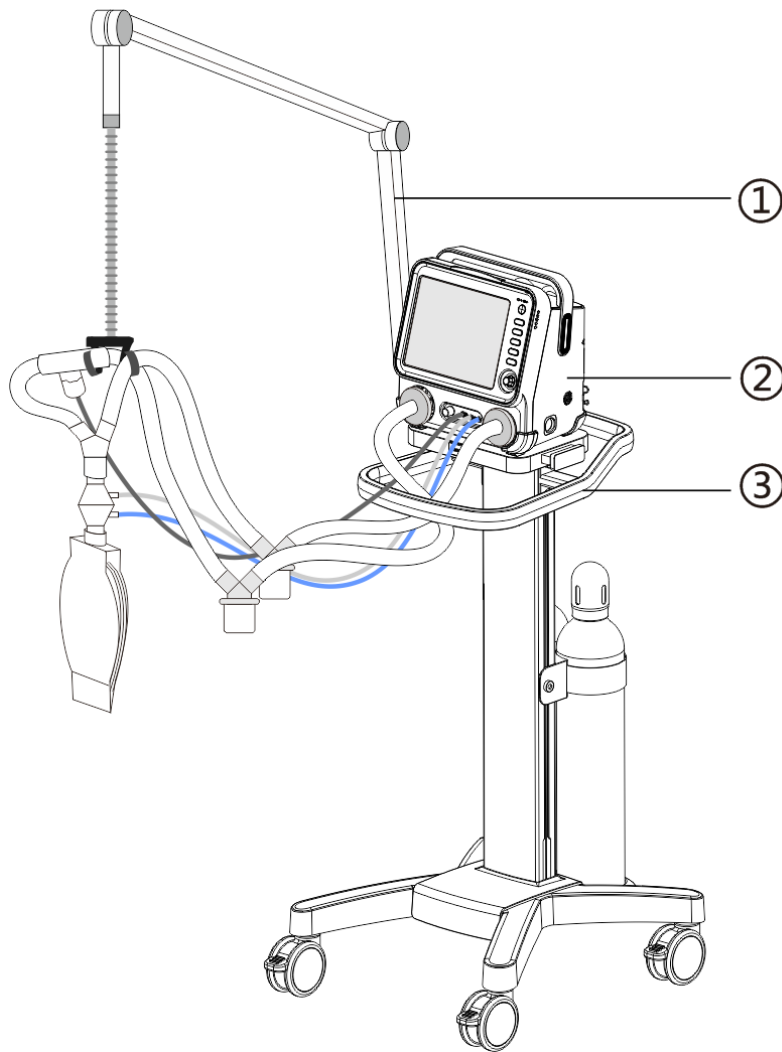

Fig. 2-5 ICV component diagram

Components	Description
1 Support arm	Used to support and suspend respiratory line of patients.
2 Mainframe	Include the gas line, electronic system, mechanical structure, display, and carbon dioxide module.
3 Trolley	Used to support the mainframe, support arm, oxygen cylinder and humidifier, etc.

3. Installation

 **Warning:**

After installation, you must do functional inspection (please refer to the "11 Maintenance and inspection") to ensure that the device works properly.

3.1. Packing items

ICV ventilator is packed in a single box. Please refer to "12 ICV accessories" for packing items.

3.2. Installation of battery

The battery used in ICV is a rechargeable lithium battery. After insertion, push it by hand, you can hear the click of the battery button, reset to ensure that the battery is installed in place (as shown below).

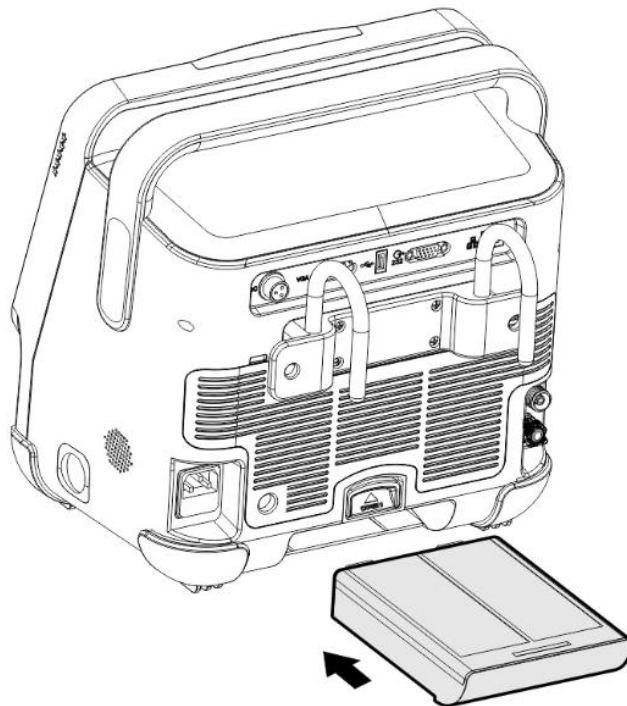

Fig. 3-1 Installation of battery

3.3. Connection of oxygen source

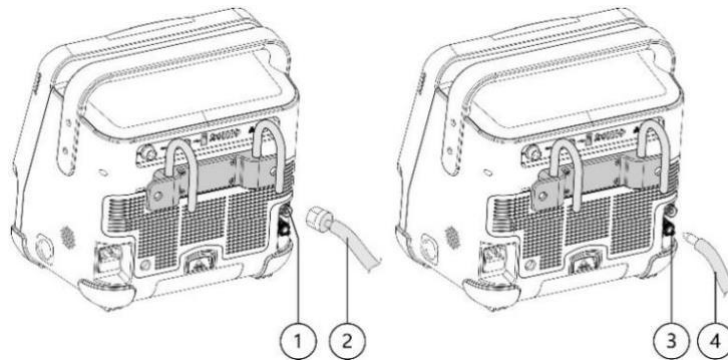

Fig. 3-2 Oxygen source interface

The ventilator can provide two gas source interfaces: high-pressure oxygen and low-pressure oxygen.

When the ventilator is connected with the high-pressure oxygen gas source, the normal working gas source pressure is 300-600kPa. If pressure of gas source is lower than 300kPa, performance of the ventilator will be affected, or even the ventilation may be disabled. When pressure of gas source is between 600 and 1,000kPa, performance of the ventilator will also be affected, but it will not cause any harm due to the high-pressure gas. The connection steps of high-pressure oxygen gas source are as follows:

- 1 . Before connecting the gas source line check if the sealing ring of the connector is in good condition .If the sealing ring is damaged, the line must not be used and the sealing ring must be replaced, otherwise it will cause gas leakage.

- 2 . Align the connector and insert it into the high-pressure oxygen gas source inlet on back of the ventilator.

- 3 . Ensure that the gas source hose and gas source inlet are connected in right place, and tighten the nuts of the hose manually.

When the ventilator is connected to the low-pressure oxygen gas source, the flow rate of low-pressure oxygen supply shall not exceed 8L / min. In order to reduce the risk of fire disaster , do not use the low-pressure oxygen gas sources whose output flow rate exceeds 8L/min. The connecting steps of the low-pressure oxygen gas source are as follows:

- 1 . Align the low-pressure oxygen source hose and insert it into the low-pressure oxygen gas source interface.

- 2 . When you hear a "pop", it shows that the gas source hose has been installed in place.

- 3 . During disassembly, the metal dome on the low-pressure oxygen gas source interface shall be pressed, and then the gas source hose shall be pulled out.

3.4. Power supply connection

The ventilator can be connected to DC power supply and AC power supply.

3.4.1. Connect AC power supply

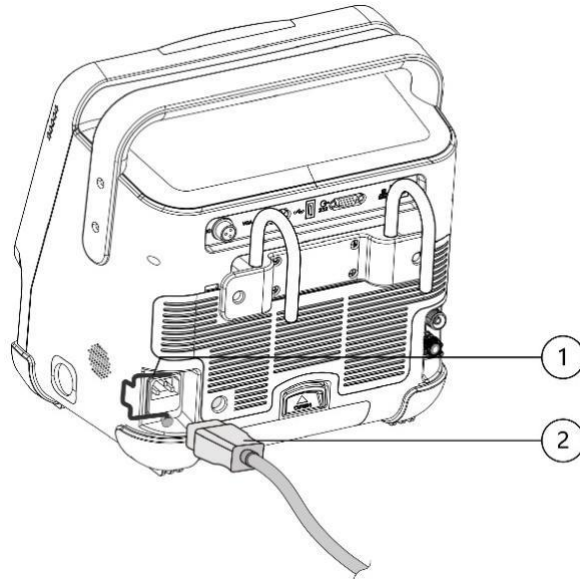

Fig. 3-3 AC power interface

- 1 . Plug the AC power cord into the AC power socket.
- 2 . Use the power cord retaining latch to secure the power cord firmly.

3.4.2. Connect DC power supply

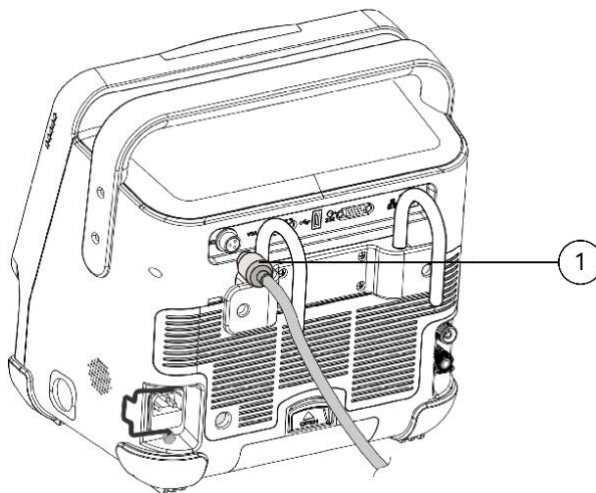

Fig. 3-4 DC power interface

Insert the DC power cord directly into the DC power input interface, and then rotate clockwise until a "Pop" sound is heard which shows that it has been installed in place.

3.5. Install the mainframe

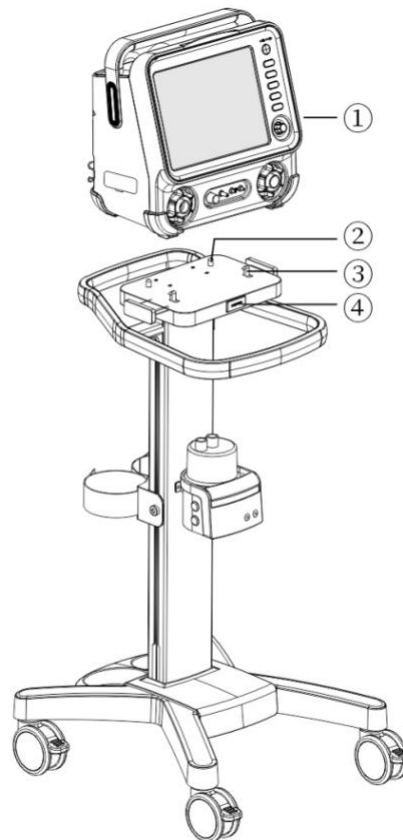

Fig. 3-5 Mainframe installation diagram

① Mainframe	② Positioning columns	③ Lock	④ PUSH key
-------------	-----------------------	--------	------------

Align the mainframe with the positioning column ,lock and fit/install it on the trolley.

Note: When removing the mainframe, press and hold the PUSH key to remove the mainframe.

3.6. Install support arm

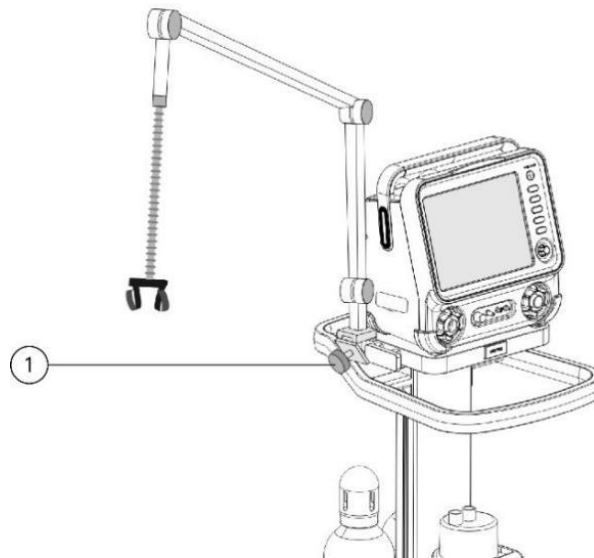

Fig. 3-6 Support arm installation diagram

1 . Loosen knob of the fixing block (① in the figure), and place the fixing block on the handrail on side of the ventilator.

2 . Tighten knob of the fixing block.

3.7. Patient respiratory line assembly and its connection

Respiratory line assembly of ICV is divided into repetitive respiratory line assembly and disposable respiratory line assembly. And connection mode of the line is: double-line connection mode. Following steps shall be followed in the connection mode (as shown below):

The respiratory hose and flow sensor in the respiratory hose assembly are connected according to the connection methods as shown in the following figure.

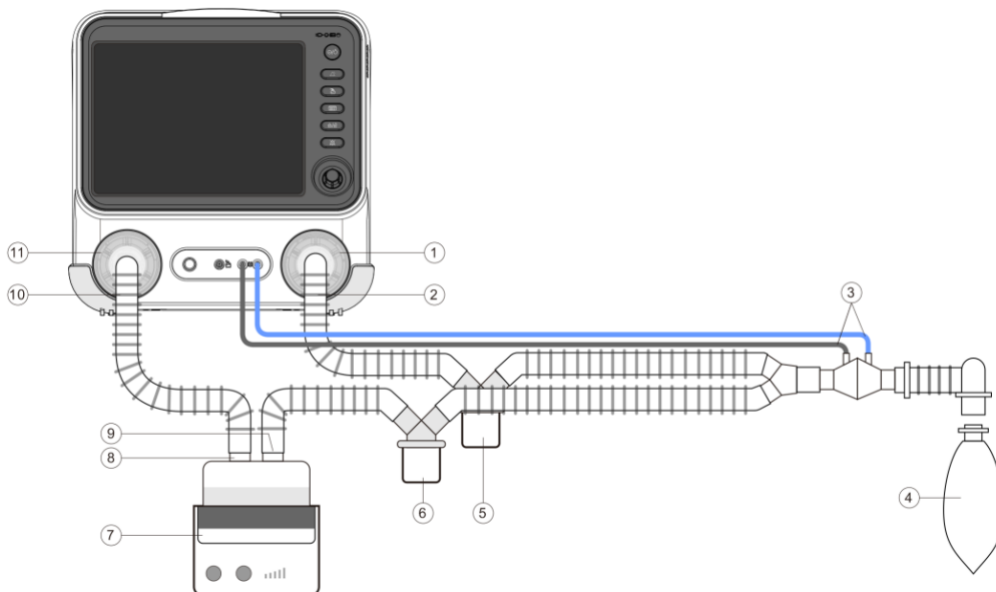

Fig. 3-7 Connection of double-line accessories

Components	Components
1 Expiratory branch filter	7 Humidifier
2 Expiratory line	8 Humidifier gas inlet
3 Flow sensor	9 Humidifier gas outlet
4 Simulated lung (patient)	10 Inspiratory line
5 Seeper trap in expiratory branch	11 Inspiratory branch filter
6 Seeper trap in inspiratory branch	

 **Caution:**

- 1 . The monitor hole to which the blue line is attached shall be placed near the patient.
- 2 . Connect the transparent PU tube of flow sensor to white interface of mainframe, and connect the blue PU tube to the blue interface.
- 3 . Insert the respiratory hose into the fresh air inlet. Be careful not to bend other connected lines.
- 4 . For the connection between other accessories and how to connect them to the patient, please refer to above diagram, "Connection of double-line accessories".
- 5 . When the ETCO₂ module is selected, connect one end of the mainstream CO₂ module to the patient and the other end to the respiratory line with flow sensor, and connect the ETCO₂ data acquisition line to ETCO₂ sampling port at the same time.

 **Warning:**

- Grasp both ends of the respiratory hose, PU tube and nebulizer connecting tube, and rotate them to insert and pull out, otherwise the respiratory hose may be damaged or broken when inserting and pulling out the respiratory hose.
- The turbofan will cause heating of the gas. Ensure that length of the patient line from humidifier to Y-shaped connector is greater than 1.2 m, in order to reduce temperature of the gas in the line and to avoid causing injuries to the patient.
- If disposable respiratory hose assembly is used, it shall be discarded after use.

3.8. Install humidifier

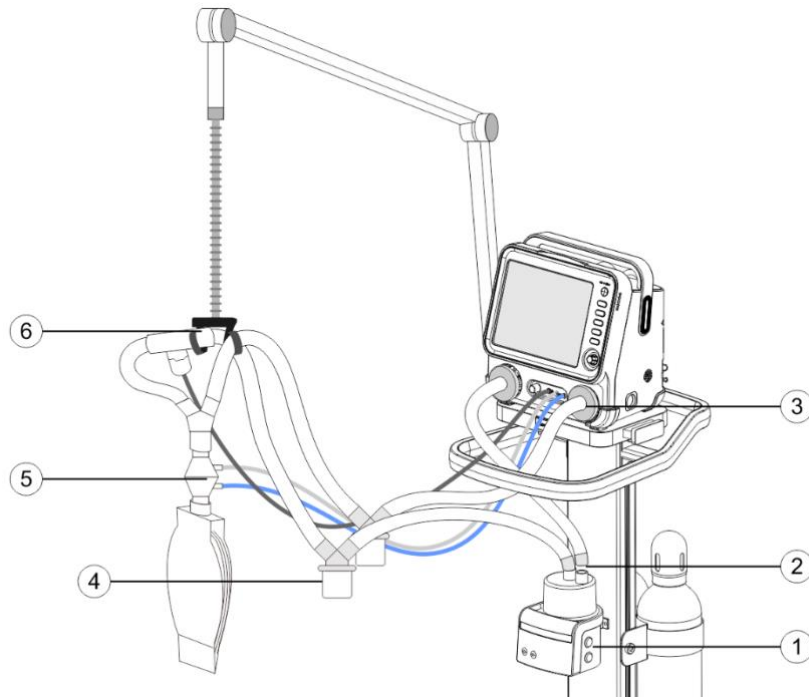

Fig. 3-8 Humidifier installation diagram

Parts	Parts
1 Humidifier	2 Humidifier air-intake tube
3 Humidifier exhalation tube	4 Sump tank
5 External flow sensor	6 Nebulizer

1 . Align humidifier pulley with the humidifier support mounting seat and slide it in, and then tighten the screws.

2 . Install the filter in the inspiratory and expiratory ports.

3 . Connect the filter of the inspiratory branch to the humidifier inlet via the line.

4 . Connect the humidifier outlet to seeper cup via the line, and then connect the seeper cup to the Y-shaped connector via the line.

5 . Connect the filter of the expiratory branch to the seeper cup via the line, and then connect the seeper cup to the Y-shaped connector via the line.

6 . Place the respiratory line on hook of the support arm.

3.9. Infant invasive pipeline connection

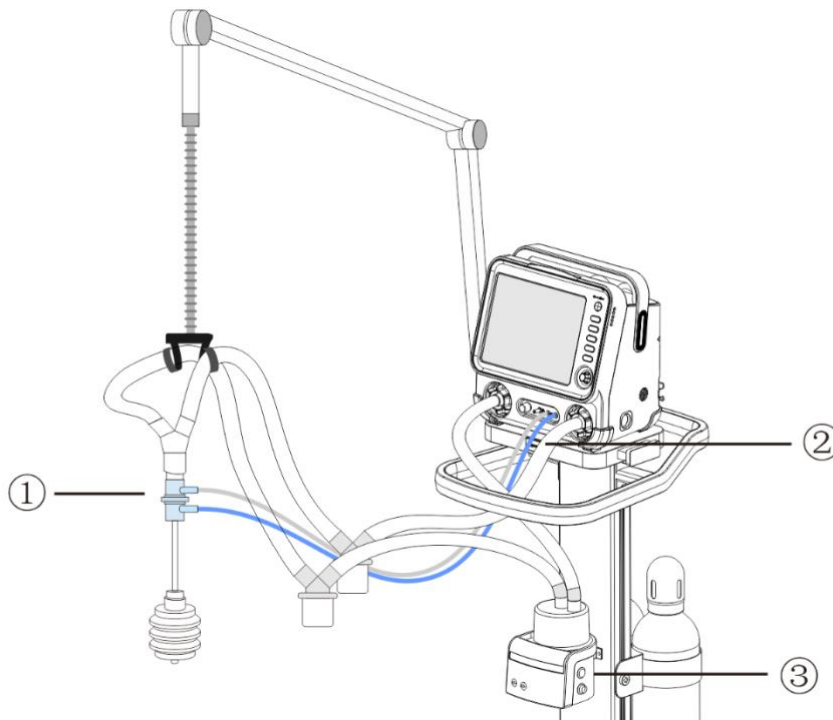

Fig. 3-9 Schematic diagram of infant invasive pipeline connection

Parts	Parts
① Infant flow sensor	② Expiratory line
③ Humidifier	

3.10. Infant noninvasive pipeline connection

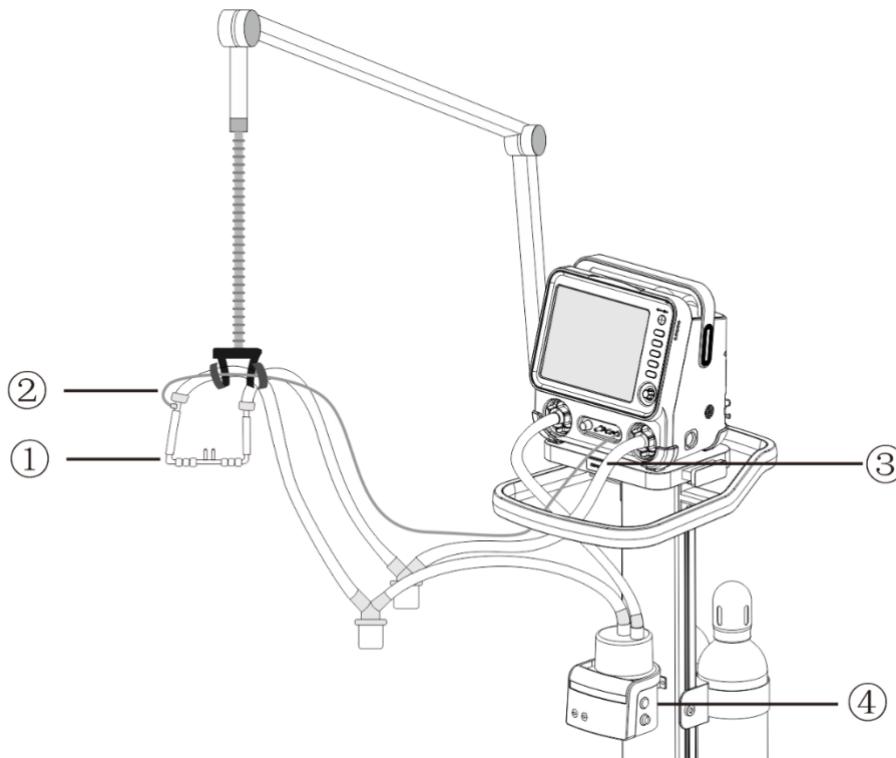

Fig. 3-10 Schematic diagram of noninvasive pipeline connection for infants

Parts	Parts
① Infant nasal oxygen tube	② Pressure pipeline tube
③ Expiratory line	④ Humidifier

Warning:

Infant patients:

- You can only select CPAP, PCV mode or switch from CPAP, PCV mode to other modes during standby.
- When switching from CPAP, PCV mode to other modes (and vice versa), you must calibrate the pipeline (for pressure pipeline) or flow sensor.
- The infant flow sensor requires that the respiratory line can be used in all ventilation modes except CPAP mode and PCV mode. When using CPAP mode and PCV mode, remove the flow sensor and use the pressure monitoring line with respiratory line.

3.11. Install nebulization

Nebulization refers to the atomization of medicines into aerosols, which are then inhaled into the patient's body for the purpose of treatment. Connect the nebulizer to the machine correctly, as shown in the figure below:

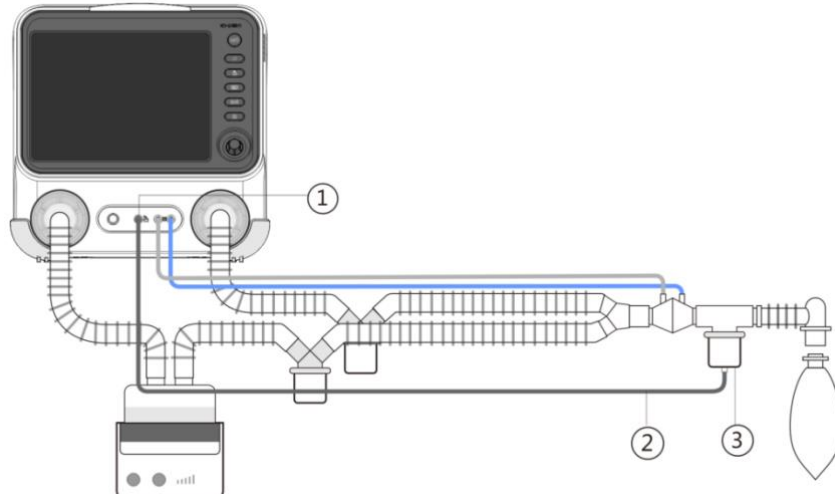

Fig. 3-11 Nebulizer installation diagram

Parts	Parts
1 Nebulization port	2 Nebulization air-intake tube
3 Pneumatic nebulizer	

3.12. Install EtCO₂

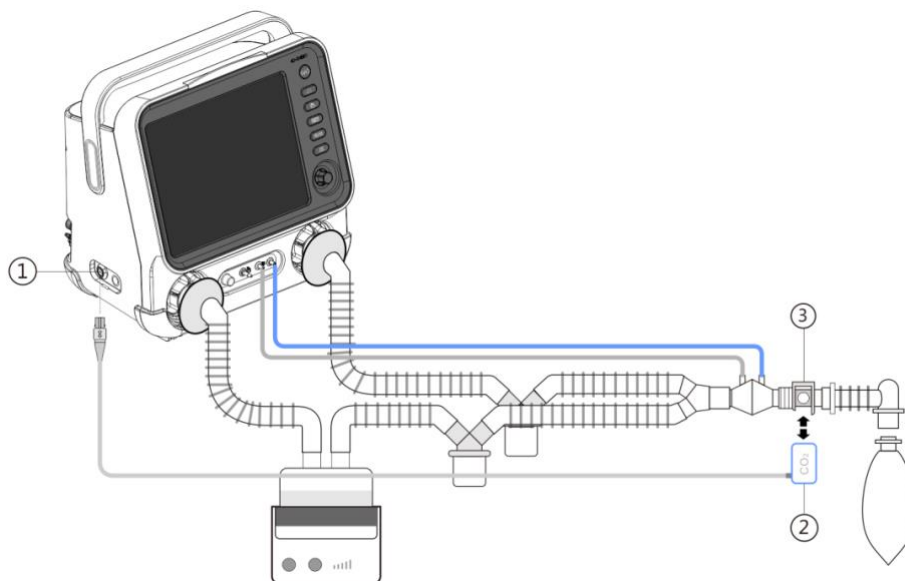

Fig. 3-12 EtCO₂ installation diagram

Parts	Parts
1 CO ₂ module port module	2 Mainstream CO ₂ monitoring
3 CO ₂ module adapter	

3.13. Patient breathe valve

3.13.1. Patient inspiratory valve

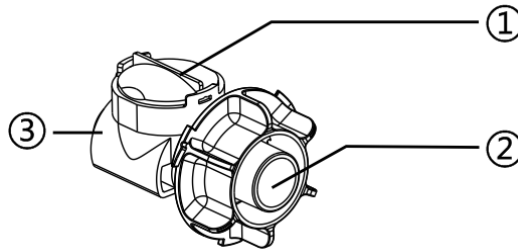

Fig. 3-13 Patient inspiratory valve

Components	Description
1 Safety valve cover	Can be used to replace diaphragm of the safety valve.
2 Gas outlet	Used to connect to patient inspiratory line, and is provided with a $\Phi 15\text{mm}/22\text{mm}$ coaxial interface.
3 Safety valve vent port	It is used for vent of the safety valve, and is strictly forbidden to be blocked.

3.13.2. Patient expiratory valve

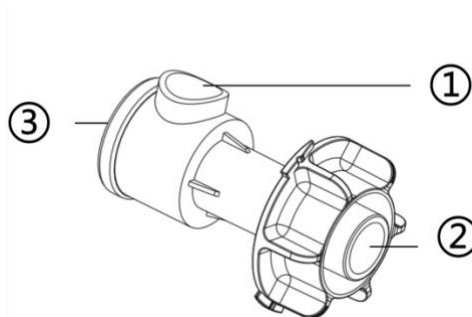

Fig. 3-14 Patient expiratory valve

Components	Description
1 Gas outlet	It is used as the patient expiratory outlet, and is strictly forbidden to be blocked.

2 Gas inlet	Used to connect to patient expiratory line, and is provided with a Φ 15mm/22mm coaxial interface.
3 PEEP valve disc	/

 **Warning:**

The manufacturer, Gradian Health Systems, is not responsible for any performance problems caused by use of the respiratory line components provided by other manufacturers.

4. Interface description

4.1. Main interface components

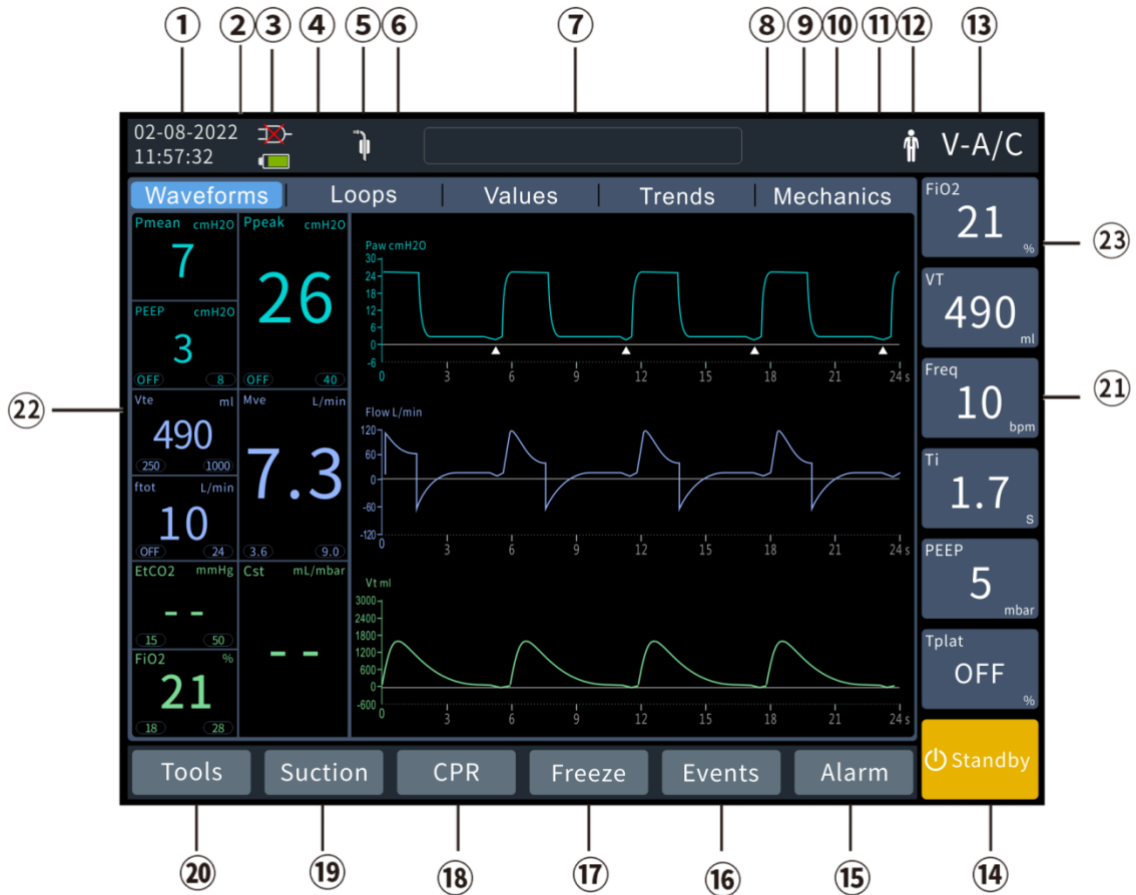

Fig. 4-1 Main interface

Components	Description
1 System date and time	Display current date and time.
2 Power supply service state	Display battery power and charging status.
3 Adapter state	Show whether the adapter is in place.
4 Patient trigger	Indicate that current respiration is triggered by the patient.
5 Invasive/non-invasive	Indicate that current ventilation type (invasive or non-invasive).
6 Nebulization	Indicate whether atomization is currently turned on.

Components	Description
7 Alarm/hint message area	Display alarm and message hints.
8 Lock screen	Display locking status of screen.
9 USB	Display that the USB is connected now.
10 Freezing mode	Displays the waveform freeze status.
11 Alarm mute prompt icon	Display current alarm mute state.
12 Patient type icon	Display current patient type (adult/Pediatric).
13 Ventilation mode	Display current mode. After selecting, the mode selection interface can be brought up to re-select the mode.
14 Standby	After selecting, enter into standby mode.
15 Alarm limit	The alarm limit interface can be brought up after selecting.
16 Log	The current patient log can be viewed after selecting.
17 Freezing	After selection, the current interface waveform can be frozen.
18 CPR	After selection, you can operate it in CPR mode.
19 Suction	After selection, suction is prompted and the mainframe will automatically carry out oxygen aeration. At this time, suction can be performed on the patient.
20 Tools	A special tool can be opened.
21 Parameter setting area	
22 Parameter monitoring area	
23 Waveform area	

 **Caution:**

All the operations that can be selected or confirmed by touch screen can also be performed by the navigation knob, which will not be repeated below, and it is considered to be available by default.

4.2. Waveform interface

Select the [Waveforms] button on the main interface screen to open the interface as shown in the figure below.

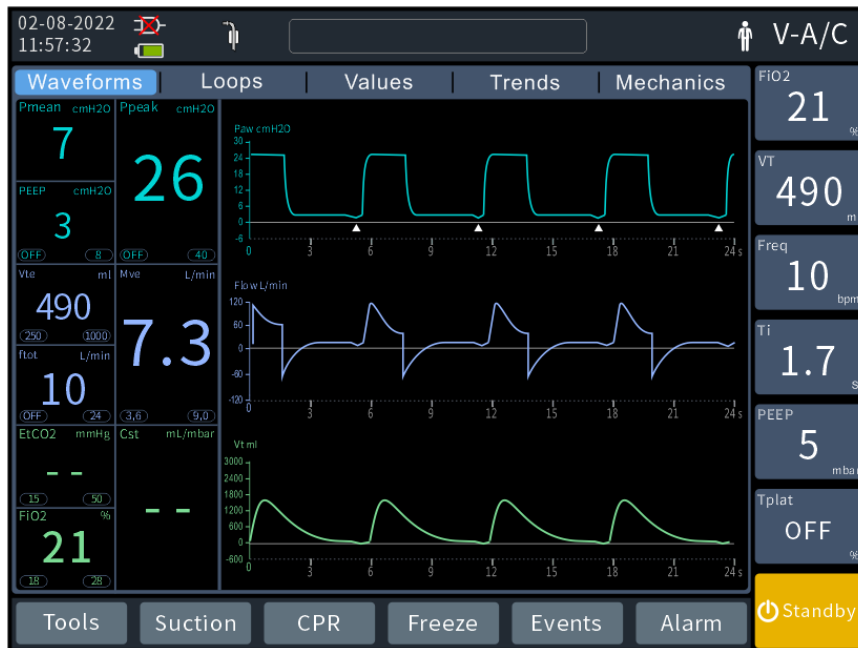

Fig. 4-2 Waveform interface

4.2.1. Respiration Parameters switching

In the main interface, click the parameters on the right side, double click to pop up the switching options, set the value and then select to switch.

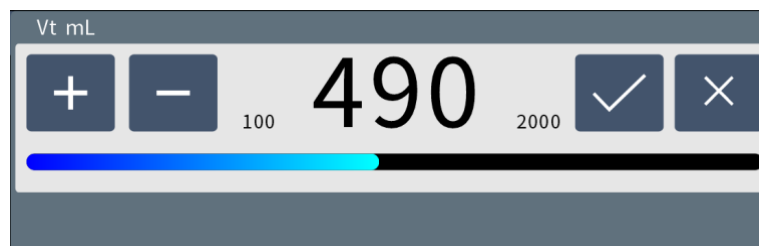

Fig. 4-3 Respiration Parameters switching

4.2.2. Monitor Parameters switching

In the main interface, click the parameters on the left side, double click to pop up the switching options, and then select to switch.

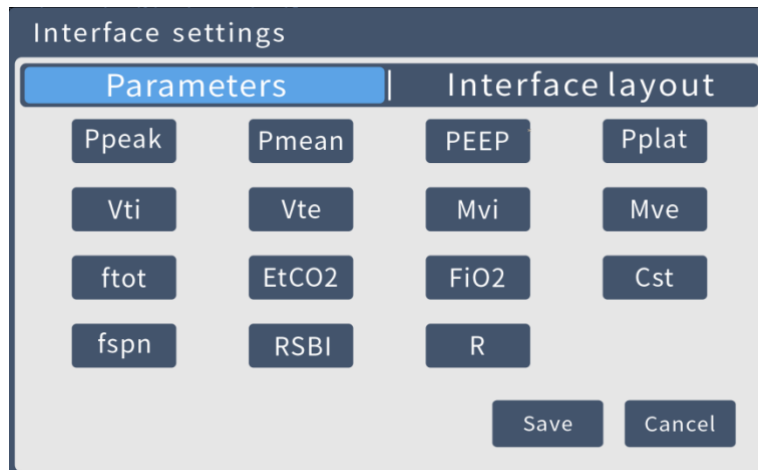

Fig. 4-4 Parameters switching

4.2.3. Monitor waveform switching

In the main interface, click the waveform to be switched, double click to pop up the switching options, and then select to switch.

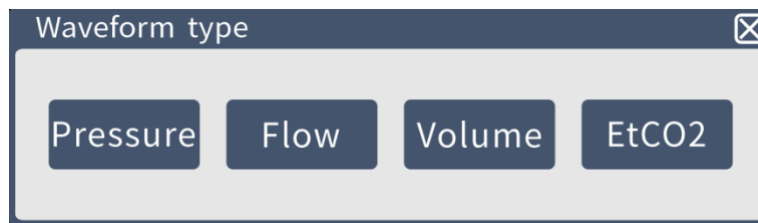

Fig. 4-5 Waveform switching



Caution:

Waveform interface, figure switching interface, monitoring value interface, trend chart interface and mechanics interface can be switched by double clicking the waveform or parameter to be switched, which will not be repeated below.

4.3. Loops interface

Select the [Loops] button on the main interface to open the interface as shown in the figure below. This interface can display the combination of 2 loops and 1 waveform on the same screen.

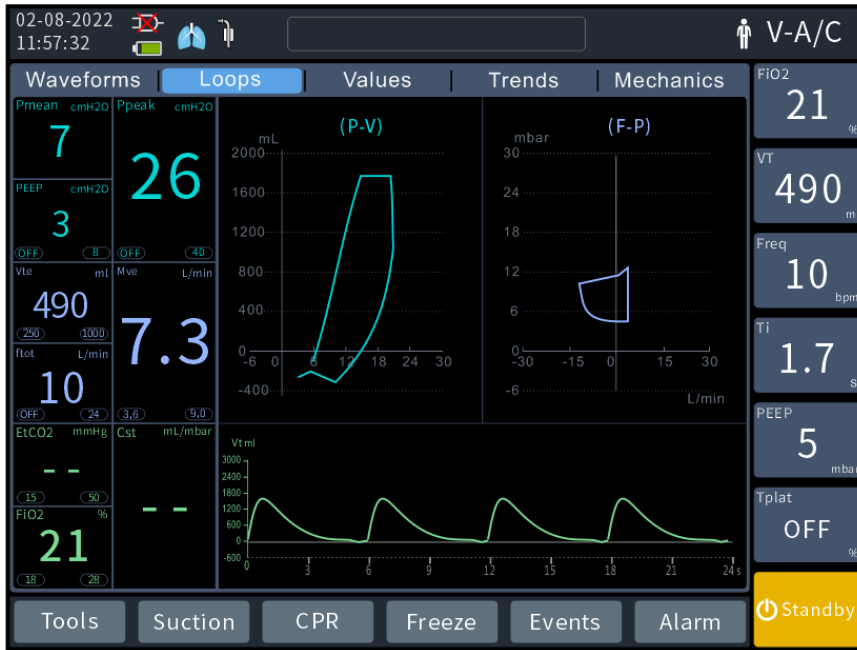

Fig. 4-6 Loops interface

4.4. Monitoring value interface

Select the [values] on the main interface to open the interface as shown in the figure below.

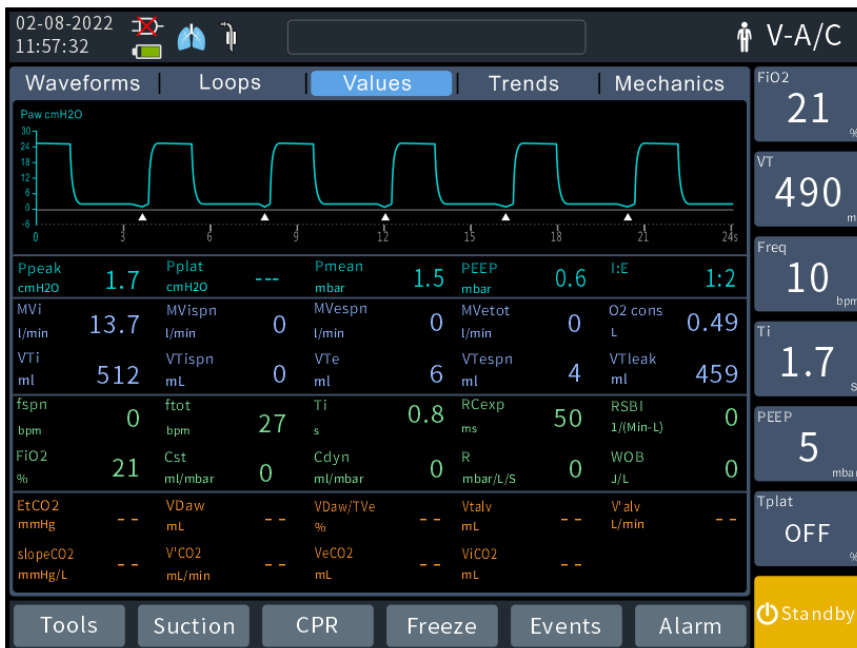

Fig. 4-7 Monitoring value interface

4.5. Trend Chart interface

In the main interface, select the [Trends] option to pop up the trend setting interface. Enter the trend interface.

You can set up the trend Chart or view trend data and trend waveforms in this interface. And view the 5min, 15min, 30min, 60min trend charts. The trend chart can be saved for a maximum of 168 hours.

4.6. Mechanics interface

Select [Mechanics] on the main interface to open the interface as shown in the figure below.

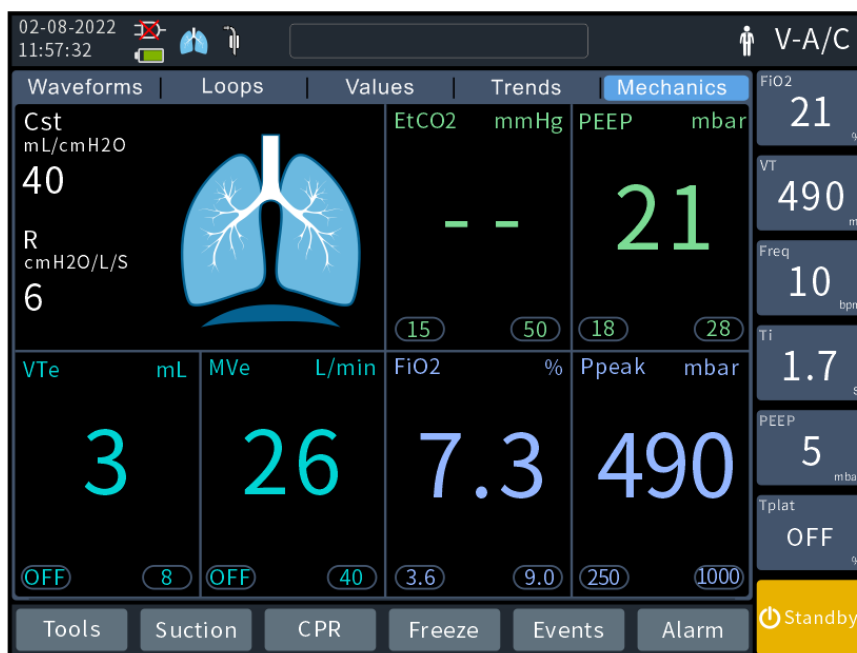

Fig. 4-8 Mechanics interface

4.7. Freeze

The freezing function is to temporarily stop real-time refresh of waveform and loops data on the screen, so as to review data of patient for a short period of time, and to observe condition of the patient during this period in detail. The data reviewed are the waveforms and loops 30 seconds before entering the freezing state.

When the "Freeze" is pressed again, the freezing state can be canceled.

4.8. Events

The system has logging function. Users can click the "Events" button in main interface to enter the events interface to view the system events. At present, the system supports storage of up to 5,000 messages. When the maximum number of log messages is reached, the newer event will overwrite the older ones. The following points shall be noted when viewing the logs:

- Events structure: time + type + message.
- Events type: alarm message, user usage information, system operation message.

- Events message: specific message description.
- Color of events: red for advanced alarms; yellow for middle-level alarms, and black for others.
- The events can be viewed by category: display all, alarms, and events.

4.9. Settings

In the main menu, you can optimize settings of the mainframe to adapt to different usage situations. The main menu can be brought up by pressing the  soft button on right side of the machine, and then corresponding settings can be made by the navigation knob or touching.

Components	Description
1 System	To set the screen brightness, unit, desktop style, waveform style, voice, waveform content and loops content.
2 Normal	To set general functions of the device
3 Maintenance/Repair	To maintain and calibrate the device
4 About this device	To view main software version number, control software version number and power board software version number of the device

4.9.1. System

In the [System] interface, you can set the system parameters according to your needs (as shown below).



Fig. 4-9 System settings

Keys	Description
1 Time setting	Year, month, day, hour, minute
2 Language	Chinese (default). Adjustable range: Chinese, English
3 Volume	Level 1 (default). Adjustable level 1-3
4 Luminance	Level 3 (default). Adjustable range: level 1-3
5 Style	Night (default). Adjustable range: night, day
6 Pressure	mbar (default). Adjustable range: mbar, hPa, cmH2O
7 Waveform style	Filling (default). Adjustable range: filling, line

4.9.2. General



Fig. 4-10 General setting

Keys	Description
1 Nebu time	Set the nebulization time:1-90 min (adjustable)
2 Nebu Position	Inhalation pipe/ patient end optional
3 Max Hold Time	1-40s (adjustable)
4 Gas standard	ATPD, STPD, BTPS (adjustable)
5 Humidifer type	Artificial nose and humidifier (optional)
6 LPO	Open and close optional
7 O2 sensor	Indicate whether the oxygen concentration sensor is connected
8 Height/weight	Select to set height/weight value
9 I:E/Ti	Select to set inspiration and expiration ratio/inspiratory time
10.VT/IBW	Select to set VT value

4.9.3. Maintenance

From [Settings]→[Maintenance], you can enter the Maintenance interface, which contains the user maintenance and manufacturer maintenance function.



Fig. 4-11 Maintenance interface

1 . For user maintenance function, in the standby interface, click [Settings] → [Maintenance] → [User maintenance] (for the maintenance operation, please refer to 11 “Maintenance and inspection”):

- EtCO2 Zeroing (8.4.EtCO2 zero calibration)
- Calibrate oxygen concentration sensor (11.6 Oxygen concentration calibration)
- Flow sensor calibration (11.7 Flow sensor calibration)
- Calibration touchscreen (11.5 Touch screen calibration)
- Data export (7.10 Data Export)
- Oxygen consumption data (7.9 oxygen consumption)

2 . For manufacturer maintenance function, in the standby interface, click [Settings] → [Maintenance] → [Manufacturer maintenance] (this function is temporarily unavailable to users)

4.9.4.About

In the " Settings " → "About", view the software version.

5. Special functions

5.1. Lung recruitment maneuver(RM)

Lung recruitment maneuver is a pulmonary protective ventilation strategy. The applying of a pressure higher than the normal mean airway pressure and maintaining it for a certain period of time during mechanical ventilation can enable reexpansion of more collapsed alveoli on one hand, and prevent secondary atelectasis caused by small tidal volume ventilation on the other hand.

1. click [Tools] → [Recruitment maneuver (RM)] in the main interface to open the recruitment tool and set the corresponding parameters.
2. Click [Measure], and the system will perform the recruitment maneuver according to the preset parameters.
3. Click [Cancel] to stop the current recruitment maneuver.



Notices:

- The use of recruitment maneuvers is not recommended when the patient is breathing spontaneously.
- If the patient's physiological state is abnormal, it is recommended to terminate the recruitment process.
- It's not available with HFNC, CPR, sputum suction and infant types.

5.2. CPR

CPR (Cardiopulmonary Resuscitation) mode is a procedure used in first aid. CPR is a mode of emergency ventilation for circulatory or respiratory arrest, which is designed to maintain oxygen supply to the patient's body tissues and assist the discharge of CO₂ inside the body. CPR mode adopted constant-volume controlled ventilation, which can be operated by selecting [30:2], [15:2] and [continuous compression]. The ventilation volume can be set by users, and the preset volume is different for different patient types.

It mainly includes the following steps:

- 1 . Step 1: Select CPR
 - 30:2: Namely, 30 pressings and 2 default ventilations are given.
 - 15:2: Namely, 15 pressings and 2 default ventilations are given.
 - Continuous pressing: That is, pressings are accompanied by default ventilation.
- 2 . Step 2: Start CPR by following the voice prompts and the "Dong Dong Dong..."beat

 **Caution:**

Continuous mode It's not available in infant types.

5.3. PEEPi

PEEPi (endogenous PEEP) refers to the positive end-expiratory alveolar pressure in the absence of exogenous PEEP.

1. Select [Tools] key → [Diagnosis] → [PEEPi].
2. Select the [PEEPi] button to enter the PEEPi measurement interface.
3. After selecting the [Start] button in the opened interface, the system will start the PEEPi measurement.
4. After measurement, the system will display the measurement results. The ventilator is able to display results of the last three measurements.

 **Caution:**

- PEEPi function is not available in CPAP/PSV mode.
- Manual breath, inspiratory hold, and expiratory hold functions cannot be initiated during PEEPi measurements.
- It's not available with HFNC, CPR and infant types.

5.4. P0.1

P0.1 refers to the pressure drop within the first 100ms when the patient begins to breathe autonomously.

- 1 . Select [Tools] key → [Diagnosis] → [P0.1].
- 2 . Select the [P0.1] button to enter the P0.1 measurement interface.
- 3 . After selecting the [Start] button in the opened interface, the system will start the P0.1 measurement.
- 4 . After measurement, the system will display the measurement results. The ventilator is able to display results of the last three measurements.

 **Caution:**

It's not available in IPPV, PCV, CPAP/PSV, HFNC, CPR and infant types.

5.5. NIF

NIF means the maximum negative pressure generated by the patient breathing spontaneously over a period of time.

- 1 . Select [Tools] button → [Diagnostics] → [NIF].
- 2 . After pressing the [Exp Hold] button, the system will start the measurement.
- 3 . After releasing the [Exp Hold] button or the button is automatically released 15 seconds later, the measurement is completed, and the system will display the measurement results.
- 4 . The respirator can display the results of the last three measurements.

⚠ Caution:

It's not available with HFNC, CPR and infant types.

5.6. Dynamic lung

The size of the lungs indicates the inspiratory and expiratory process. During inspiration, the lung is larger. During exhalation, the lung is smaller. Click [Mechanics] on the main interface to see the dynamic lung interface.

The dynamic lung state is as follows:

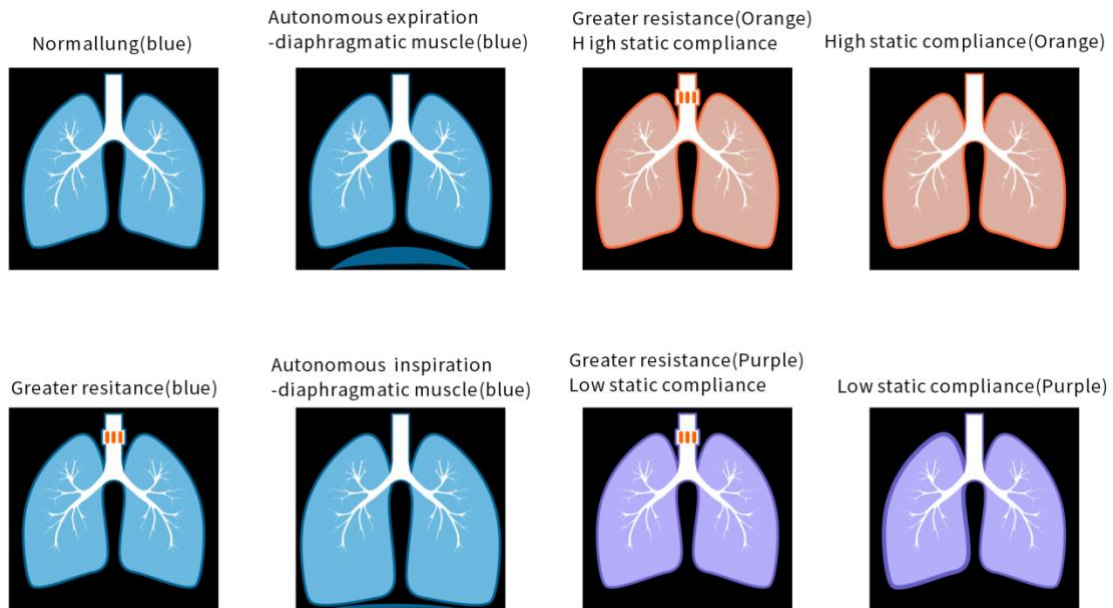

Fig. 5-1 Dynamic lung

5.7. Suction

Sputum suction is the process during which ventilator is used to assist the user to suck sputum of the patient. The ventilator automatically detects the action of the user disconnecting and connecting the patient's tube, applies oxygenated ventilation before and after sputum suction, and block relevant alarms during the process of sputum suction.

- 1 . Click [Suction] on the home screen, and the ventilator will automatically start the oxygenating function for 120s.

2 . Once you disconnect the patient's catheter, the system alerts [Patient's catheter disconnected! Please reconnect the patient once suctioning is complete!]

3 . Once the operation for the patient is completed, please connect the patient's catheter. When a tube connection is detected, the system will oxygenate and ventilate the patient for 120 seconds.



Caution :

- P0.1, PEEPi, and NIF are not able to be started once the sputum suction is initiated.
- Not available in CPR mode.
- 100% pure oxygen is given during the oxygenating stage for the Adult type, and 1.25 times of the current oxygen concentration value is given for the pediatric and infant type.

5.8. Insp. holding

Inspiratory holding refers to artificially prolonging the patient's inspiratory stage and preventing the patient from expiration for a certain period of time.

1 . After selecting the [Tools] key → [Function] → [Insp.Hold], and pressing the [Insp.Hold] key continuously, the ventilator will enable the inspiratory holding function, and the system will prompt [Insp. Hold...]. After releasing the [Insp.Hold] key, the ventilator will disable the inspiratory holding function.

2 . The maximum duration of inspiratory holding is 40 seconds. When the [Insp.Hold] key is pressed for more than 40 seconds, the ventilator will automatically disable the inspiratory holding function.

3 . The maximum duration of inspiratory holding can be set in the [Functions] menu → [General] and [Max Hold Time] option.

4 . During inspiratory holding, the machine will automatically calculate the patient's Pplat and display it in the prompt bar.



Caution:

- Not available in HFNC, CPR and CPAP mode.
- You can not activate Insp Hold function in CPAP/PSV ventilation mode. If apnea ventilation occurs, the Inspiration Hold function is supported.

5.9. Exp.holding

Expiratory holding refers to artificially prolonging the patient's expiratory stage and preventing the patient from inspiration for a certain period of time.

1 . After selecting the [Tools] key → [Function] → [Exp.Hold], and pressing the [Exp.Hold] key continuously, the ventilator will enable the expiratory holding function, and the system will prompt [Exp.Hold ...]. After releasing the [Exp.Hold] key, the ventilator will disable the expiratory holding function. After you release the [Exp.Hold] key, the ventilator will automatically disable the expiratory holding function.

2 . During Expiratory holding, the machine will automatically calculate the patient's PEEP_i and display it in the prompt bar.

3 . The maximum duration of Expiratory holding is 60 seconds. When the [Exp.Hold] key is pressed for more than 60 seconds, the ventilator will automatically disable the Expiratory holding function.



Caution:

- Not available in HFNC, CPR and CPAP mode.
- You can not activate Expiration Hold function in CPAP/PSV ventilation mode. If apnea ventilation occurs, the Expiration Hold function is supported.

5.10. Manual

After selecting [Tools] key → [Function] and clicking [Manual], the machine will automatically provide one inspiration or respiration in the current ventilation mode.





Caution:

- Not available in HFNC and CPR mode.
- You can not activate Manual Ventilation function in CPAP/PSV ventilation mode. If apnea ventilation occurs, the Manual function is supported.

5.11. Nebulization

Press the  soft key on the right side of the machine to enable the nebulization function.

After clicking the  → [General] → [Nebu time], and selecting the [Save] button after setting, and the ventilator will work according to the set nebulization time. After the nebulization function is enabled, remaining time of this function will be displayed in the system prompt message area.

When the nebulization time is reached or the  key is clicked again, the ventilator will disable the nebulization function.



Caution:

- In the presence of aerosol products, EtCO₂ cannot be measured. Remove EtCO₂ monitoring module before activating the nebulization function. Sampling and monitoring functions on the EtCO₂ module are suspended.

- When type of patient is infant, nebulization function is ineffective.

- When the oxygen gas source type is low-pressure oxygen, the nebulization function cannot be enabled.

- Drugs may block expiratory valve and flow sensor during nebulization, because of which inspection and cleaning shall be carried out after nebulization.

- Increased gas from the nebulizer may affect ventilator accuracy.

- Nebulization is not available when inspiratory flow rate is lower than 15 L/min.

- In CPAP/PSV mode, the nebulization function is not available.

5.12. P-V tool

Mechanical ventilation set at optimal PEEP can improve oxygenation, improve alveolar mechanics, and reduce lung injury. The P-V tool is a method to determine the optimal PEEP by drawing a static pressure-volume curve (static P-V loop) and then identifying the characteristic points on the static P-V loop chart curve. The physician can use this function to determine the optimal PEEP indicated for the patient.

- 1 . Select the [Tools] button → [P-V Tools]

- 2 . Click [Measure], the system will start the measurement according to the preset value.

- 3 . At the end of measurement, [Result analysis] will display tidal volume, pressure and static compliance value.

- 4 . Click [History Ring Chart] to check the last four complete measurement records.

Notices :

- It is not available when the patient is pediatric, infant & toddler.

- It is not available in CPAP/PSV, non-invasive and apnea ventilation modes.

- It is not available during the process of nebulization or sputum suction and within 1 minute after the process, and not available within 1 minute after the last P-V test.

6. Alarm

6.1. Alarm message

The alarm messages with the highest priority at present will be displayed in the alarm prompt bar on the main interface. If there are multiple alarms, you can click the alarm prompt message bar in the main interface, and the alarm message interface will be brought up to view other alarm messages (as shown below).

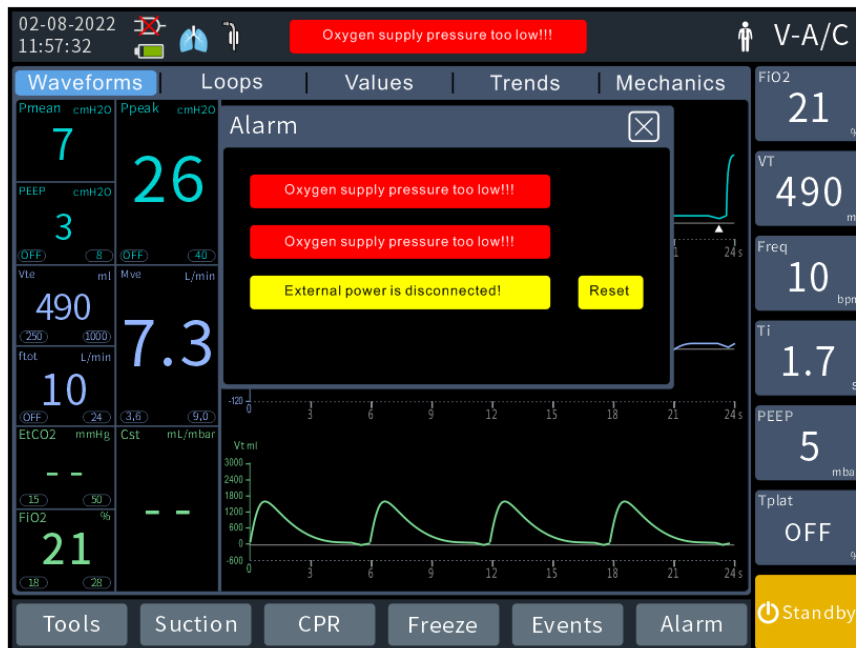

Fig. 6-1 Alarm prompt

6.2. Alarm priority

Each alarm will correspond to a type of alarm priority, and a variety of alarm phenomena may be produced. It can effectively alert medical staff when any abnormal conditions occur. Exception handling shall be carried out to prevent the occurrence of unexpected events. Description of the alarm function is detailed as follows:

- **Priority:**

Type	LCD	LED	Voice alarm
High-priority alarm	The alarm area on the main interface will turn red and corresponding alarm texts+ will be displayed!!!	The red light flashes Flash frequency: 0.5s each time.	1. Five continuous “beep--beep--beep----beep-beep-” sounds will be heard, the pulse interval is 0.1s 0.1s 0.5s 0.1s , the duration of pulse is 0.2s, and the

Type	LCD	LED	Voice alarm
			interval of pulse group is 7s.
Medium-priority alarms	The alarm area on the main interface will turn red and corresponding alarm texts+!! will be displayed.	The yellow light flashes Flash frequency: 2s each time.	1. Three continuous “beep--beep--beep” sounds will be heard, the pulse interval is 0.1s 0.1s , the duration of pulse is 0.1s, and the interval of pulse group is 24s.
Low-priority alarms	The alarm area on the main interface will turn yellow and corresponding alarm texts+! will be displayed	The yellow light will remain on.	1. A “Beep” sound will be heard every 24s.

6.3. Technical Alarm

Alarm code	Alarm name	Alarm description	Priority
1000	Failure 1000!	Oxygen valve failure	High
1001	Failure 1001!	Turbine failure	High
1002	Failure 1002!	Control valve failure	High
1003	Failure 1003!	Output flow sensor failure	High
1004	Failure 1004!	Air flow sensor failure	High
1005	Failure 1005!	Oxygen flow sensor failure	High
1006	Failure 1006!	Internal flow sensor measurement error	High
1007	Failure 1007!	Output pressure sensor failure	High

Alarm code	Alarm name	Alarm description	Priority
1008	Failure 1008!	Input gas temperature sensor failure	High
1009	Failure 1009!	Output gas temperature sensor failure	High
1010	Failure 1010!	Motor temperature sensor failure	High
1011	Failure 1011!	Motor temperature read failure	High
1012	Failure 1012!	Oxygen supply pressure sensor failure	High
1013	Failure 1013!	Ambient pressure sensor 1 failure	High
1014	Failure 1014!	Ambient pressure sensor 2 failure	High
1015	Failure 1015!	Incorrect ambient pressure measurement	High
1016	FiO2 sensor failure!!!	Oxygen concentration sensor failure	High
1017	Failure 1017!	Safety valve failure	High
1018	Failure 1018!	Patient sensor reading failure	High
1019	Failure 1019!	Ventilation module internal communication failure	High
1020	Failure 1020!	ADC conversion failure	High
1021	Failure 1021!	Module received illegal exception data	High
1022	Oxygen supply pressure is too low!	Air inlet is blocked	High

Alarm code	Alarm name	Alarm description	Priority
1023	LPO Error!!!	Oxygen supply pressure > 800 mbar	High
1024	Air inlet flow rate is low!!!	Air inlet is blocked	High
1025	Ventilation module Power supply voltage is too low!!!	$12 \pm 1V < \text{voltage} \leq 20 \pm 1V$	High
1026	Ventilation module Ultra-low power supply voltage!!!	Voltage < $12 \pm 1V$	High
1027	Motor temperature is too high!!!	$70^\circ\text{C} < \text{motor temperature} \leq 100^\circ\text{C}$	High
1028	Motor temperature exceeds the range!!!	Motor temperature > 100°C	High
1029	Patient side flow sensor failure!!!	Patient side flow sensor failure	High
1030	No valid patient flow rate measurement!!!	No valid patient flow rate measurement	High
1031	Patient side pressure sensor failure!!!	Patient side pressure sensor failure	High
1032	No pressure sensor!!!	No pressure sensor	High
1033	High temp of input gas!!!	Input gas temperature greater than 50°C	High
1034	High temp of output gas!!!	Output gas temperature is greater than 50°C	High
1035	Hose Obstruction!!!	The hose is blocked	High
1036	Hose Obstruction!!!	The hose is blocked	High
1037	Breathing ducts disconnected!!!	The breathing tube is detached	High

Alarm code	Alarm name	Alarm description	Priority
1038	Maximum pressure !	Maximum pressure limit reached	Low
1039	PRVC min value reached!	PRVC min value reached	Low
1040	PRVC max value reached!	PRVC max value reached	Low
1041	Emergency pressure relief!	Emergency pressure released	Low
1042	Pressure released to PEEP!	Pressure released to PEEP	Low
1043	Pressure released to the ambient!	Pressure released to the environment	Low

6.4. Physiological alarm

Alarm code	Alarm name	Alarm description	Priority
2000	High Paw!!!	Airway pressure is above upper limit	High
2001	Low Paw!!!	Airway pressure is below lower limit	High
2002	High MV!!!	Minute ventilation volume is above upper limit	High
2003	Low MV!!!	Minute volume is below lower limit	High
2004	High FiO2!!!	Oxygen concentration is above upper limit	High
2005	Low FiO2!!!	Oxygen concentration is below lower limit	High
2006	High EtCO ₂ !!!	EtCO ₂ is above upper limit	High

Alarm code	Alarm name	Alarm description	Priority
2007	Low EtCO ₂ !!!	EtCO ₂ is below lower limit	High
2008	High PEEP!!!	PEEP is above upper limit	High
2009	Low PEEP!	PEEP is below lower limit	Medium
2010	High flow!!!	CPAP mode, flow rate is above alarm limit	High
2011	High VT!!	Tidal Volume is above upper limit	Medium
2012	Low VT!!	Tidal volume is below lower limit	Medium
2013	High RR!!	Respiratory rate is above upper limit	Medium
2014	Low RR!!	Respiratory rate is below lower limit	Medium
2015	Patient apnea!!!	Patient suffered from apnea for a period longer than Suffocation time	High

6.5. Battery alarms

Alarm code	Alarm name	Alarm description	Priority
1044	Battery failure!!!	No output from battery	High
1045	Battery charging failure!!!	Battery can not be recharged	High
1046	Abnormal battery comm!!!	Battery and power board fail to communicate properly	High
1047	Battery is aged!!!	Full charged battery service	High

		time is too short	
1048	No battery detected!!!	Battery not found	High
1049	Low battery!!!	Battery life time \leq 20 minutes	Medium
1050	About to shut down, so connect to external power supply!!!	Battery life time \leq 5 minutes	High
1051	Battery temp is too high, may turn off!!!	High temperature during battery discharge, and the system is about to shut down. (>75 °C)	High
1052	Battery temp is high, connect the external power!!	High temperature during battery discharge (≥ 65 °C)	Medium
1053	External power disconnected!	External power supply disconnected	Low

6.6. Communication Alarms

Alarm code	Alarm name	Alarm description	Priority
3000	Vent module comm. error!!!	Main board communicating with gas module error	High
3001	Power module comm. error!!!	Main board communicating with power board error	High

6.7. Alarm rules

Condition	LED	LCD	Horn alarm
Multiple high-priority alarms are given simultaneously	Only the alarm messages with the highest priority will be displayed in the prompt area;	The red light flashes, Flash frequency: 0.5s each time.	If it is a beep alarm, it will be given with high priority in the

Condition	LED	LCD	Horn alarm
	however, all alarm messages are displayed in the alarm interface.		form of beeps.
Multiple medium-priority alarms are given synchronously	Only the alarm messages with the highest priority will be displayed in the prompt area; however, all alarm messages are displayed in the alarm interface.	The yellow light flashes, flash frequency: 2s each time.	If it is a beep alarm, it will be given with medium priority in the form of beeps.
Multi-ple low-priority alarms are given synchronously	Only the alarm messages with the highest priority will be displayed in the prompt area; however, all alarm messages are displayed in the alarm interface.	The yellow light is always on.	If it is a beep alarm, it will be given with low priority in the form of beeps.
High , medium and low priority alarms are given synchronously	Only the alarm messages with the highest priority will be displayed in the prompt area; however, all alarm messages are displayed in the alarm interface.	The red light flashes, Flash frequency: 0.5s each time.	If it is a beep alarm, it will be given with high priority in the form of beeps.

6.8. Alarm mode

Alarm mute:

- Press the mute button  to turn on or off the sound. If a new alarm is triggered during alarm mute, the voice alarm will be turned on again.
- The duration of alarm mute is 120s; after pressing the alarm mute, the sound

will be muted for 120s; and, if the alarm still exists after 120s, it shall be restarted to turn on the sound.

- Adjustment of alarm volume:
 - Press the  soft key, and click [System] → [Volume] to adjust the sound volume from :close , Level 1-3 .

Alarm cancellation:

When the alarm limit is set to [OFF], the system will turn off the physiological alarm of the corresponding parameters. Namely, the text message, visual alarm, audible alarm and parameter flashing of the physiological alarm are all canceled.

6.9. Setting of alarm limits

Alarm limits can be set according to physiological characteristics of the patient's breathing. The steps are as follows:

- 1 . In the main interface, select [Alarm Limit] via the navigation knob.
- 2 . Select the alarm limits that you want to change, and press the navigation knob or directly touch to select.
- 3 . Change the alarm limits selected, and press the navigation key again to determine.
- 4 . Repeat step 2 and 3 to change the alarm limits that you want to change.
- 5 . After the “Save” button is clicked, the changed parameters will take effect.

6.10. Alarm parameter range

S/N	Alarm parameter	Alarm range
1	Upper limit of tidal volume	3-3,000mL, closed
2	Lower limit of tidal volume	Closed, 1-2,000mL
3	Upper limit of breath rate	5bpm-155bpm, closed
4	Lower limit of breath rate	Closed, 1bpm-145bpm
5	Upper limit of minute ventilation	0.02L/min ~ 50L/min
6	Lower limit of minute ventilation	0.01L/min ~ 25L/min

S/N	Alarm parameter	Alarm range
7	Upper limit of oxygen concentration	19%~100%
8	Lower limit of oxygen concentration	18%~99%
9	Upper limit of positive end expiratory pressure	1cmH ₂ O-50 cmH ₂ O
10	Lower limit of positive end expiratory pressure	Closed, 1cmH ₂ O-40 cmH ₂ O
11	Upper limit of airway pressure	12cmH ₂ O ~ 100 cmH ₂ O
12	Lower limit of airway pressure	Closed, 1cmH ₂ O-90 cmH ₂ O
13	Apnea	5s ~ 60s
14	Gas source pressure is insufficient	Pressure of oxygen source is below 250 kPa
15	Gas source failure	Pressure of oxygen source is below 110 kPa
16	Respiratory system integrity alarm	There will be an alarm when the respiratory line and other respiratory accessories are disconnected
17	Upper limit of end-tidal carbon dioxide	1mmHg-150mmHg, closed
18	Lower limit of end-tidal carbon dioxide	Closed, 1mmHg-149mmHg
19	Battery power is low	The device shall work for at least 20min from starting of an alarm to shutdown
20	The battery power is too low	The battery is running low
21	External power supply is	External power supply is

S/N	Alarm parameter	Alarm range
	disconnected	disconnected

7. Operations

7.1. Power-on

Plug the power cord into power outlet. Make sure the external power indicator is on.

1 . Press the [ON/OFF] button to turn on ICV.

2 . At this time, a progress bar indicating that the ventilator is subjected to self-inspection will appear on the screen. After the self-inspection, the main interface will pop up.

3 . If self-inspection fails, an error code will be displayed on the screen. At this point, the ventilator cannot be used.

7.2. Self check and calibration

After starting the system, it will automatically enter the system calibration interface, and the machine will automatically perform self-inspection and calibration of the gas line. During the self-inspection and calibration pipeline compliance, artificial operation should be carried out according to the prompts of the self-inspection interface. The steps are as follows:

1 . Remove the flow sensor and plug the Y-shaped port of the line on the special leak test plug on the right side of the ventilator.

2 . After completing this step 1 self-inspection, connect the adapter of the flow sensor for calibration according to the prompt. After completing the flow sensor reversal, remove the adapter and follow the interface prompts to connect the flow sensor properly.



Caution:

During the self-inspection, complete the operation first according to the interface prompts and then click the [Start] button for self-check.

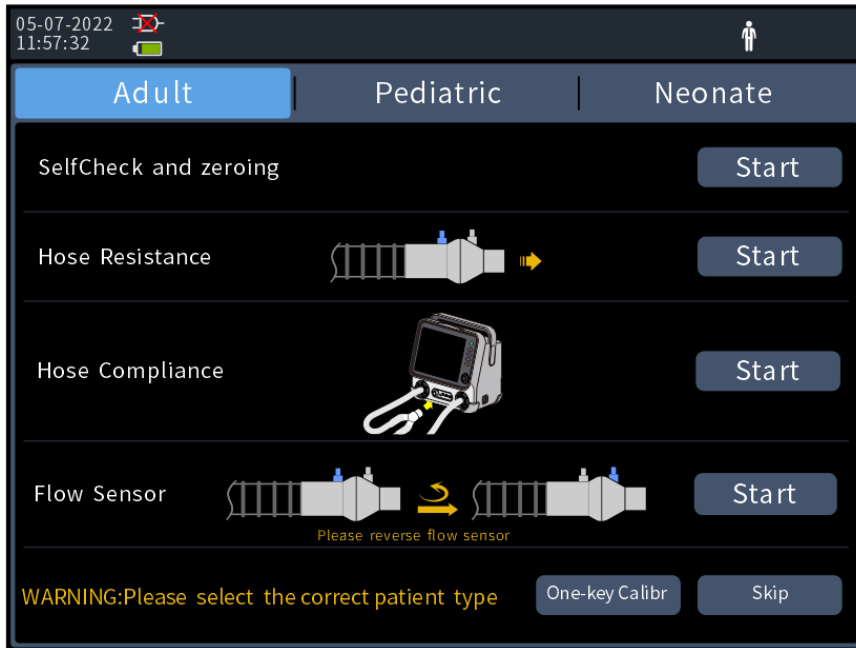

Fig. 7-1 Startup calibration interface

System calibration includes:

- Self check and zeroing
- Hose resistance
- Hose compliance
- Flow sensor

⚠ Caution:

- The automatic self-inspection function is not intended as a substitute for function inspection. When using the machine, function inspection of the machine shall be carried out according to the contents described in "10 Maintenance and inspection".
- Each time the patient type is switched, the system must be calibrated before ventilation can be initiated.

7.3. Select the patient

System startup calibration interface. In this interface, you can choose the type of patients: adult, pediatric, neonate.

Please select the type of patient after calibration. If you select the [Previous patient], set [Ventilation type] in the menu that is opened, and then select [Start ventilation]. If a [new patient] is selected, set [Gender], [Height]/[Ideal weight], [Ventilation type] (invasive(IV) or non-invasive(NIV)) in the menu that is opened, and then select [Start] ventilation.

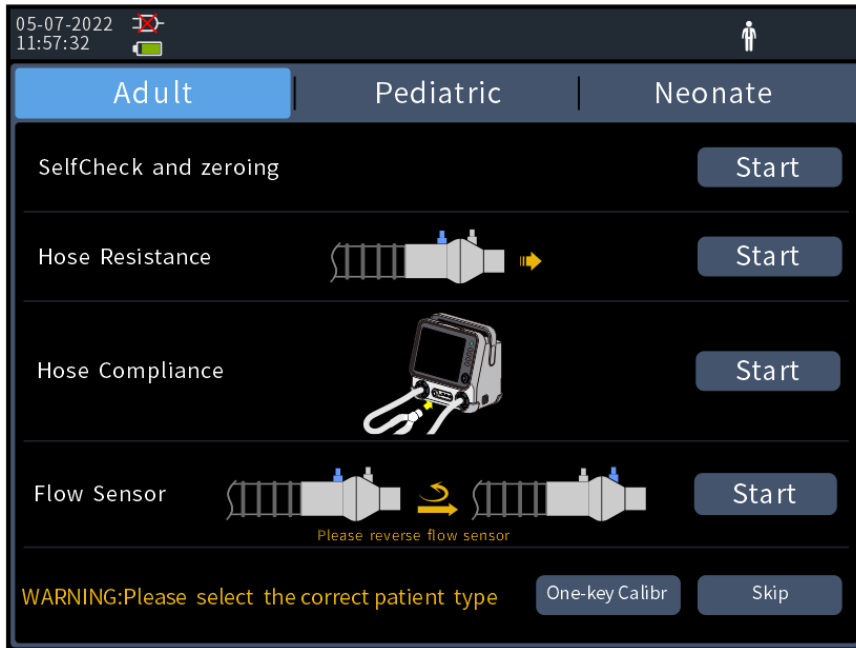

Fig. 7-2 Patient type selection

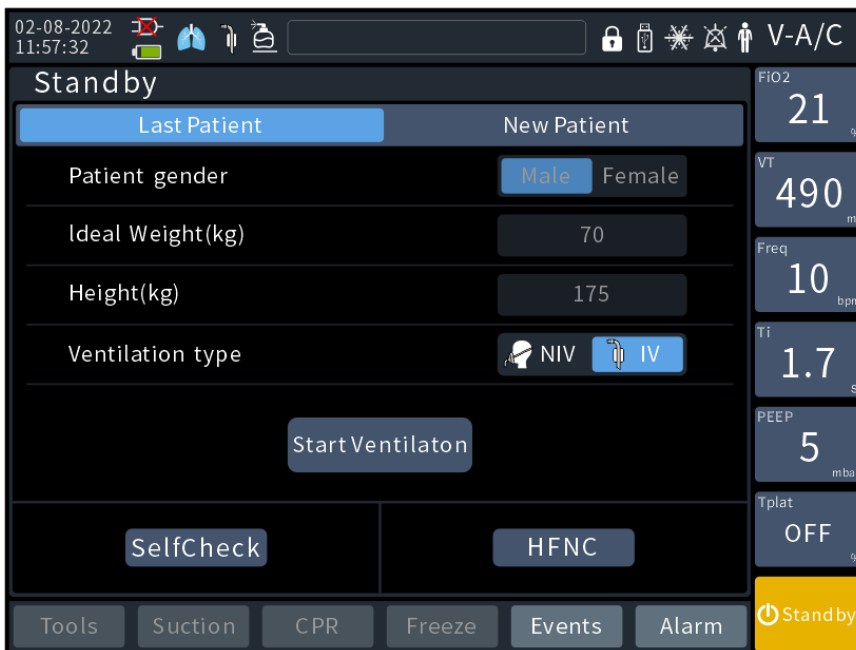

Fig. 7-3 Patient setting



Caution:

- Each time you switch patient types, a system calibration must be performed to initiate ventilation.
- If you select the previous patient's ventilation, the machine will use the previous patient ventilation settings and alarm settings by default.

7.4. Ventilation type

This ventilator has two ventilation types: invasive ventilation and non-invasive ventilation.

Caution:

When switching from noninvasive to invasive ventilation the setting of the alarm limit should be checked.

7.4.1. Invasive ventilation(IV)

Invasive ventilation is the ventilation of the patient through connection of artificial airway (endotracheal intubation and tracheotomy). The modes of ventilation that can be initiated with invasive ventilation include: P-A/C, IPPV, PCV, P-A/C, V-SIMV, P-SIMV, PRVC, PRVC -SIMV, APRV, BiPPV, CPAP/PSV ,and under infant types: PCV, P-A/C, PRVC, PRVC-SIMV, P-SIMV, APRV, BiPPV, CPAP/PSV.

Caution:

Do not attempt to use noninvasive ventilation on a patient with endotracheal intubation.

7.4.2. Non-invasive ventilation(NIV)

Non-invasive ventilation refers to the fact that the ventilation of patient is enabled by a nasal mask or respiratory mask without endotracheal intubation or tracheotomy intubation. In non-invasive ventilation mode, the following is available for adult and pediatric types: P-A/C, P-SIMV, APRV, BiPPV, CPAP/PSV, and in infant types: CPAP, PCV.

Notices:

- Non-invasive ventilation shall not be used in patients with no or irregular autonomous respiration.
- Non-invasive ventilation is expected to provide supplementary ventilation support for patients with regular autonomous respiration.
- Do not attempt to use noninvasive ventilation on a patient with endotracheal intubation.

7.5. Selecting ventilation mode

Simply select the <Ventilation Mode> on the main interface to bring up the Ventilation Mode interface and then select the ventilation mode you needed (as shown below).



Fig. 7-4 Ventilation Mode interface

7.6. Ventilation settings

7.6.1. Ventilation parameter setting

After selecting the ventilation mode button in upper right corner of the interface in ventilation mode setting menu, and the menu that is opened displays the ventilation parameters that can be set in this ventilation mode.

- 1 . Select the ventilation parameter keys to be set.
- 2 . Press the main control knob, and then rotate the knob to set the parameters to an appropriate value.
- 3 . Press the main control knob again to confirm the setting, or select [\checkmark] to confirm and save, or [\times] to cancel the operation
- 4 . Follow the same method to set other parameters that need to be set.
- 5 . After setting the parameters, select the [Save] button.

The quick setting of ventilation parameters is as follows:

- 1 . Select the ventilation parameters to be set in the parameter setting shortcut button area on the right side of the interface.
- 2 . Press the main control knob, and then rotate the knob to set the parameters to an appropriate value.
- 3 . Press the main control knob again to confirm the setting, or select [\checkmark] to confirm and save, or [\times] to cancel the operation.

4 . Follow the same method to set other parameters that needs to be set.

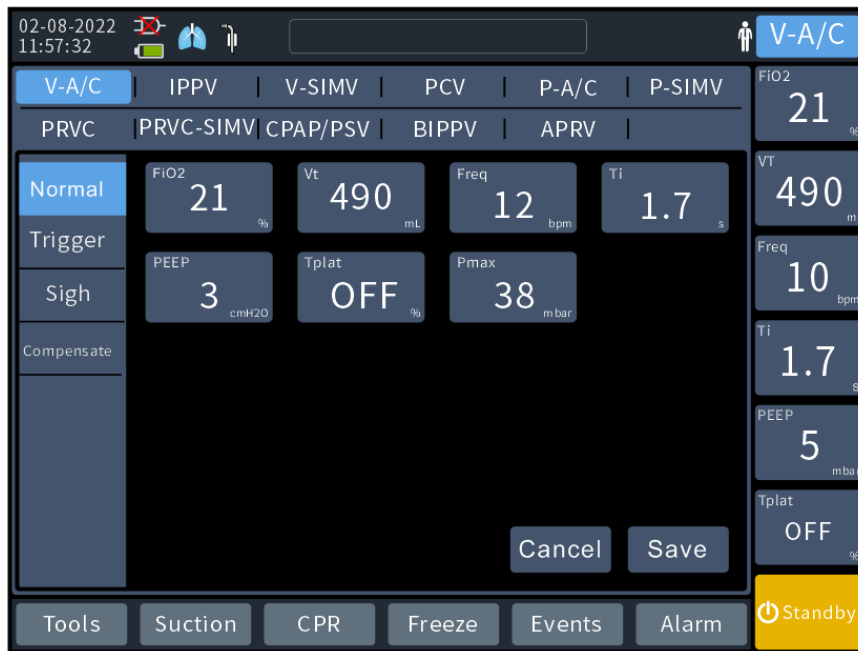

Fig. 7-5 Ventilation parameter setting

7.6.2. Ventilation parameters in each mode

Ventilation mode	Set parameters
IPPV	Tidal volume/inspiratory time/breath rate/PEEP/oxygen concentration/upper pressure limit/inspiratory pause/sigh
V-A/C	Tidal volume/inspiratory time/breath rate/PEEP/oxygen concentration/sigh/inspiratory trigger mode/inspiratory trigger threshold/upper pressure limit/inspiratory pause/sigh
V-SIMV	Tidal volume/inspiratory pause/inspiration time/inspiratory platform time/SIMV frequency/PEEP/oxygen concentration/sigh/ flow rate trigger / pressure trigger /inspiratory trigger mode/inspiratory trigger threshold/expiratory switching sensitivity/trigger window/support pressure/upper pressure limit/sigh
PCV	Inspiratory pressure/inspiratory time/pressure rise time/breath rate/PEEP/oxygen concentration/upper pressure limit/sigh
P-A/C	Inspiratory pressure/inspiratory time/pressure rise time/breath rate/PEEP/oxygen

	concentration/sigh/inspiratory trigger mode/inspiratory trigger threshold/upper pressure limit/sigh
P-SIMV	Inspiratory pressure/inspiratory time/pressure rise time/SIMV frequency/PEEP/oxygen concentration/sigh/ flow rate trigger / pressure trigger /inspiratory trigger mode/inspiratory trigger threshold/expiratory switching sensitivity/trigger window/support pressure/upper pressure limit/sigh
APRV	PEEP/oxygen concentration/low pressure time/high pressure time/high airway pressure/upper pressure limit
BiPPV	Support pressure/inspiratory trigger mode/inspiratory trigger threshold/expiratory switching sensitivity/PEEP/oxygen concentration/low pressure time/high pressure time/high airway pressure/upper pressure limit
CPAP	Support pressure/inspiratory trigger mode/inspiratory trigger threshold/expiratory switching sensitivity/PEEP/oxygen concentration/upper pressure limit
PRVC	Tidal volume/inspiratory time/pressure rise time/breath rate/ /PEEP/ PRVCmax/PRVCmin/oxygen concentration/sigh/ flow rate trigger / pressure trigger/inspiratory trigger threshold/expiratory switching sensitivity/upper pressure limit
PRVC-SIMV	Tidal volume/inspiratory time/pressure rise time /SIMV frequency/PEEP/ PRVCmax/PRVCmin/oxygen concentration/sigh/inspiratory trigger mode/ PRVC max/PRVC min /inspiratory trigger threshold/expiratory switching sensitivity/upper pressure limit/sigh
CPAP (Inf.)	PEEP/oxygen concentration/upper pressure limit
PCV (Inf.)	Inspiratory pressure/inspiratory time/pressure rise time/breath rate/PEEP/oxygen concentration/upper pressure limit
CPR	Tidal volume/oxygen concentration
HFNC	Oxygen therapy flow/oxygen concentration/upper pressure limit

7.6.3. IPPV and PCV

- **Intermittent positive pressure ventilation: IPPV**

During mechanical ventilation of IPPV (Intermittent Positive Pressure Ventilation), the ventilator always provides intermittent positive pressure ventilation. The pressure rise during inhalation/inspiration is manifested as positive pressure, while during exhalation/expiration the pressure returns to baseline pressure. For example, the patient with apnea or who is not breathing is provided with continuous respiratory support, and each respiration is mandatory. IPPV is a widely used ventilation technique in clinical practices, and is mainly used for the patients without autonomous respiration. The ventilator will provide intermittent positive pressure ventilation to the patient as per the preset ventilation parameters regardless of the condition of the patient's autonomous respiration.

- **Typical pressure waveform of IPPV is as follows:**

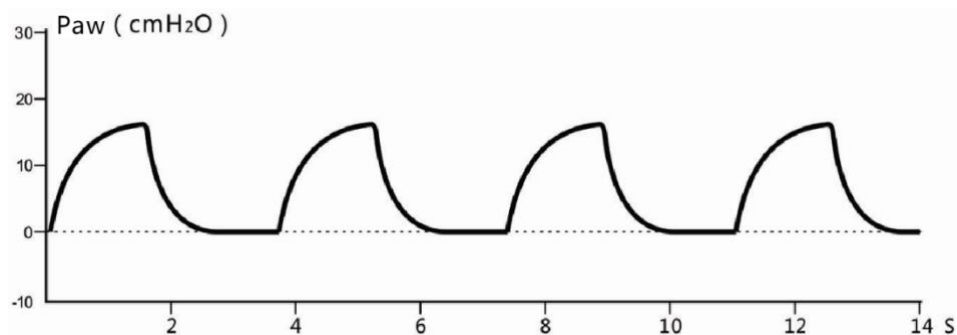

Fig. 7-6 IPPV typical pressure waveform

- **Pressure controlled ventilation: PCV**

PCV (Pressure Controlled Ventilation) – In this mode, the airway pressure and inspiration/inhalation time are preset. After inspiration begins, the gas velocity increases rapidly. After reaching the preset pressure level, the gas velocity is slowed down by the feedback system, and the preset pressure level is maintained until the end of the inspiration, and then the expiration begins. Each time the ventilation is completely carried out with full load at the preset pressure. When PCV is enabled, the airway pressure is reduced, there is no peak pressure, and the occurrence of barometric injury is less. It is beneficial to inflate the alveolar which is not easy to fill, improve the ventilation/blood flow ratio, and the gas exchange is good. PCV is mostly used in children, infants, and the patients with respiratory failure and severe ventilation/flow ratio imbalance caused by ARDS or COPD. Even when the respiratory line leaks, it can also ensure the supply of tidal volume. PCV should be used when the trachea is leaking.

Typical pressure waveform of PCV is as follows:

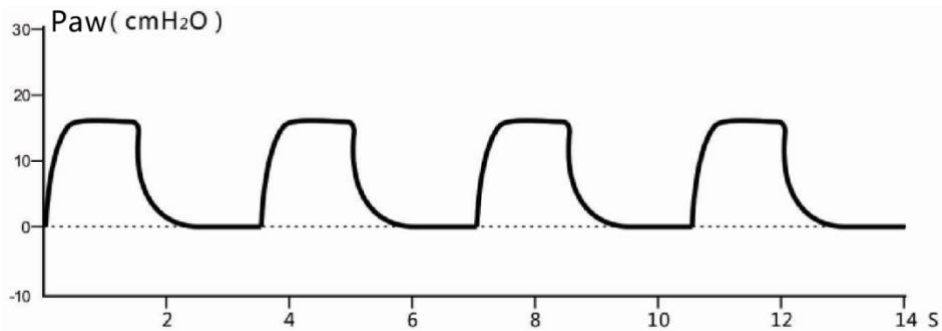

Fig. 7-7 PCV typical pressure waveform

7.6.4.V-A/C and P-A/C

- **V-A/C**

V-A/C is a volume-controlled based ventilation mode. During the expiration phase, it supports synchronous triggering. When the trigger pressure/flow meets the trigger conditions, the ventilator provides a VCV ventilation with a fixed tidal volume in advance.

The typical pressure waveform of V-A/C is shown below:

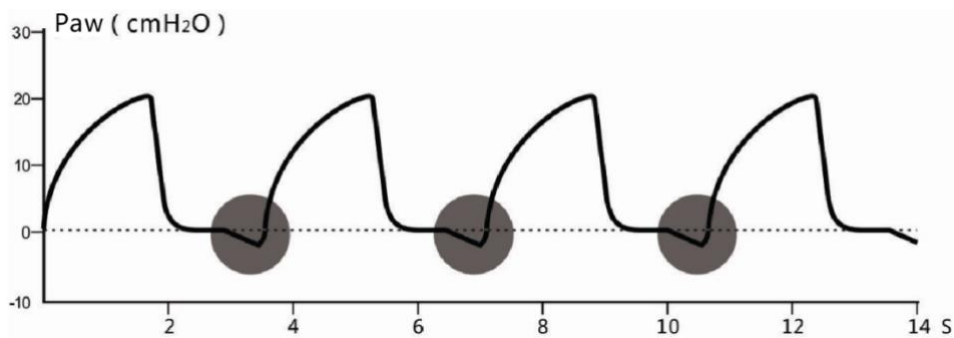

Fig. 7-8 V-A/C typical pressure waveform

- **P-A/C**

P-A/C is a pressure-controlled based ventilation mode and supports synchronous triggering during the expiratory stage. When the trigger pressure/flow rate meets the trigger conditions, the ventilator provides a PCV ventilation with fixed inspiratory pressure once in advance.

The typical pressure waveform of P-A/C is shown below:

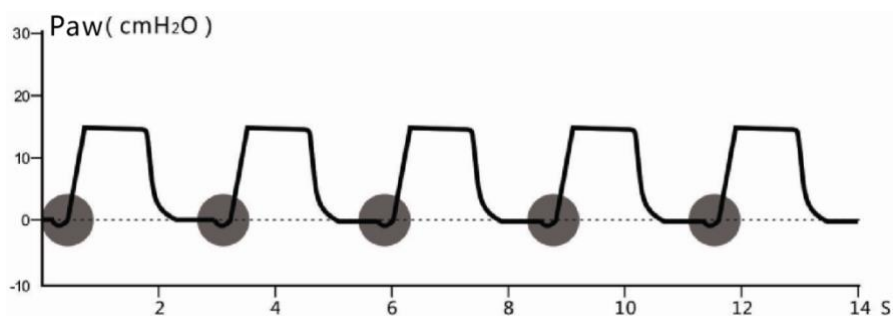

Fig. 7-9 P-A/C typical pressure waveform

The [Sigh] is a deep inspiration greater than current tidal volume/pressure at every other

set ventilation times on the basis of the specified ventilation frequency, and is applicable for the patients who need mechanical ventilation for a long time.

7.6.5.V-SIMV and P-SIMV

Synchronized intermittent mandatory ventilation: SIMV

SIMV (Synchronized intermittent Mandatory Ventilation) is a ventilation technology organically combining autonomous respiration and IPPV, which ensures effective ventilation of patients, is free of any patient-ventilator asynchrony, appropriately regulates the frequency and volume of SIMV, and is conducive to exercise respiratory function of patients. SIMV has become a clinically necessary technique before weaning from ventilator.

V-SIMV (volume controlled synchronized intermittent mandatory ventilation) refers that the machine provides support pressure in case of a triggering outside the trigger window during mechanical ventilation. In a specific trigger window, the ventilator detects the patient's inspiratory effort according to setting of trigger sensitivity and immediately gives forced ventilation once according to the preset tidal volume, so that supply of the mandatory ventilation is synchronized with the patient's inspiratory force. If the patient fails to trigger after the trigger window expires, forced ventilation will be given once.

The typical pressure waveform of V-SIMV is shown as follows:

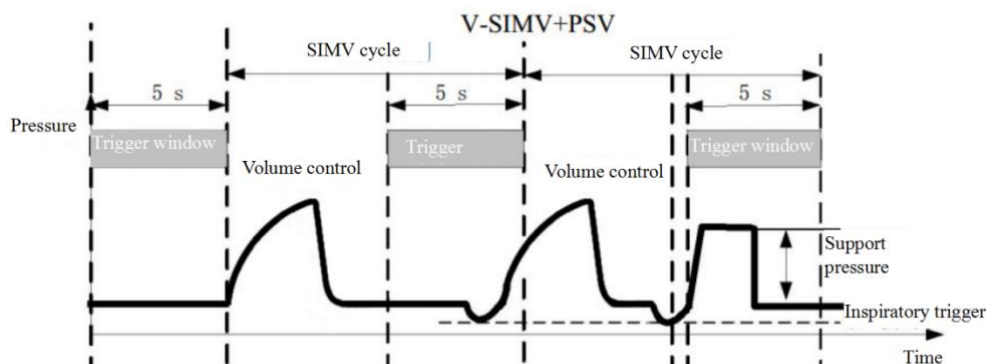

Fig. 7-10 V-SIMV typical pressure waveform

P-SIMV (pressure-limited synchronized intermittent mandatory ventilation) refers that the machine provides support pressure if the patient is able to trigger the ventilator outside the trigger window during mechanical ventilation. In a specific trigger window, the ventilator detects the patient's inspiratory effort according to setting of trigger sensitivity and immediately gives forced ventilation once according to the preset pressure, so that supply of the mandatory ventilation is synchronized with the patient's inspiratory force. If the patient is able to trigger the ventilator within the time of trigger window, auxiliary ventilation will be given. If the patient fails to trigger after the trigger window expires, forced ventilation will be given once.

The typical pressure waveform of P-SIMV is shown as follows:

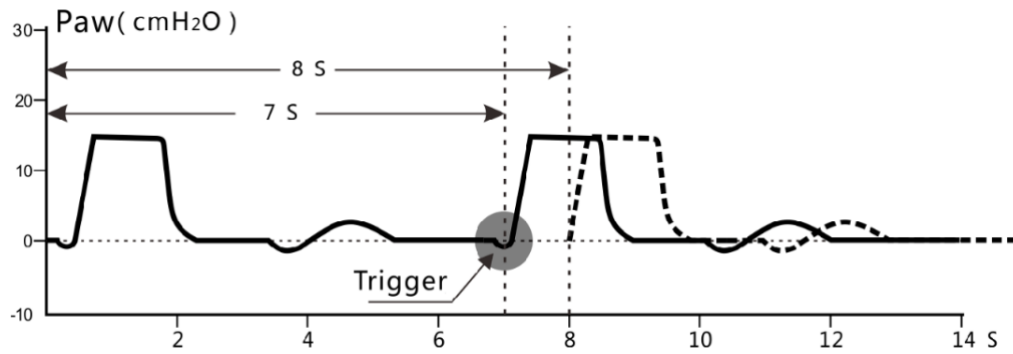

Fig. 7-11 P-SIMV typical pressure waveform

Warning:

When using this method, if the condition worsens and autonomous respiration suddenly stops, hypoventilation or hypoxia may occur.

7.6.6. CPAP/PSV

CPAP is a continuous positive airway pressure. The ventilator is equipped with a sensitive airway pressure measurement and adjustment system, which can adjust the flow rate of positive airway pressure over time in order to maintain a constant airway pressure at the predicted CPAP level. CPAP is a ventilation mode that provides a certain pressure level under the condition of spontaneous respiration, so that the positive airway pressure is maintained throughout the respiratory cycle. PSV with pressure support means the system activates a pressure support ventilation cycle when the patient's inspiratory effort reaches the preset inspiratory trigger level. The pressure rise time and pressure support level are set by the user. When the inspiration starts, the system will make the patient's airway pressure rise to the preset pressure level according to the preset pressure rise time, and then maintain this pressure level, until the patient's inspiratory flow rate reaches the expiratory trigger level.

The typical pressure waveform of CPAP/PSV is shown below:

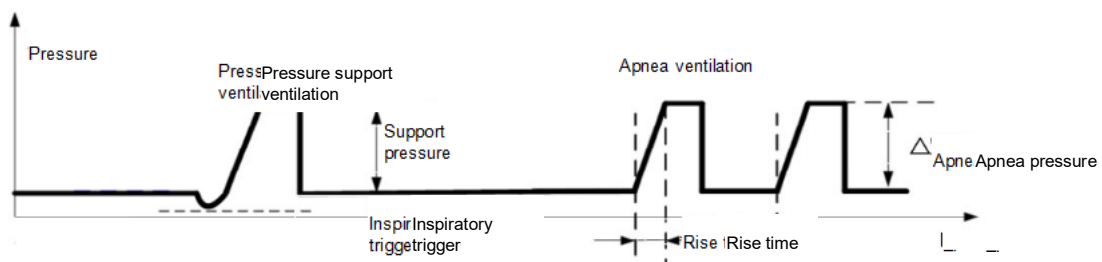

Fig. 7-12 CPAP/PSV typical pressure waveform

7.6.7. BiPPV bilevel positive airway pressure

BiPPV means that during mechanical ventilation or autonomous breathing, the ventilator alternately provide two different levels of positive airway pressure. The patient can breathe autonomously at these two pressure levels. The support pressure can be set at the low pressure stage, trigger windows can be set in both high and low pressure

stages, and low pressure support is supplied when ventilation is triggered outside the trigger window of the low pressure stage, and the inhalation trigger in the trigger window of the low pressure stage will be converted to high pressure aspiration. In the trigger window of the high pressure phase, the exhalation trigger will change to exhalation/expiration.

Parameters can be set in BiPPV mode: support pressure/flow rate trigger/pressure trigger/inspiratory trigger threshold/expiratory switch sensitivity/PEEP/oxygen concentration/low pressure time/high pressure time/high airway pressure/upper pressure limit.

Typical pressure waveform of BiPPV:

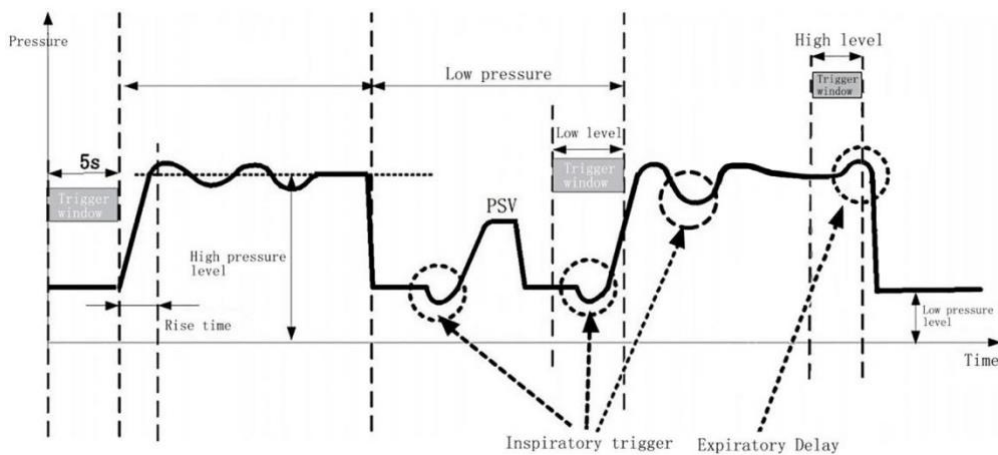

Fig. 7-13 BiPPV typical pressure waveform

7.6.8. APRV

APRV mode is known as the airway pressure release ventilation mode, which can be viewed as giving periodic and transient airway pressure release in CPAP mode.

Autonomous breathing can be performed at high pressure levels, where the support pressure can be set in the high pressure phase. And the time in the low pressure release phase is less than the high pressure ventilation time.

The typical pressure waveform of APRV:

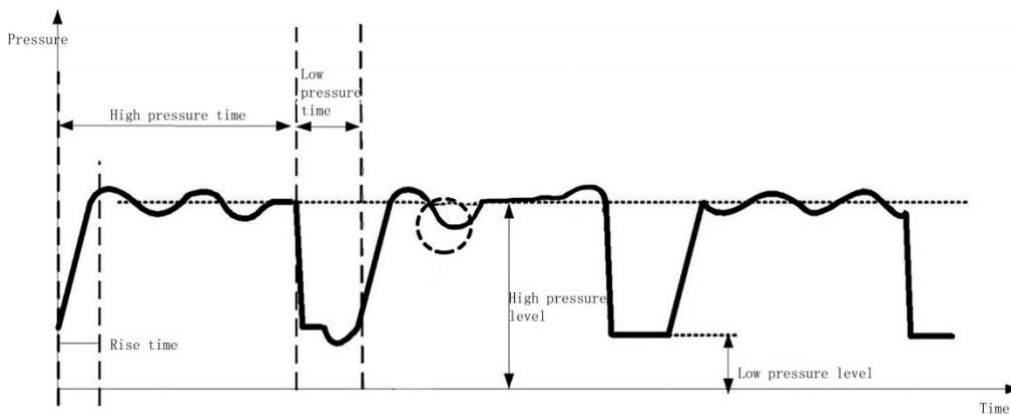

Fig. 7-14 APRV typical pressure waveform

7.6.9. PRVC

In PRVC mode, volume control is carried out in the manner of pressure-controlled ventilation. In this mode, the pressure level is kept as low as possible during inspiratory stage, and at the same time ensures that the gas supply volume is equal to the preset tidal volume for ventilation control. The pressure control level varies depending on setting size of the tidal volume and resistance compliance of the patient's lung. After completion of 3-4 times of test ventilation, the pressure increase of the machine shall not exceed 3mbar each time, the maximum pressure shall not exceed the maximum value of PRVC, and the initial control pressure is the minimum value of PRVC + 5mbar.

Typical pressure and flow velocity waveforms controlled by PRVC mode are as shown below:

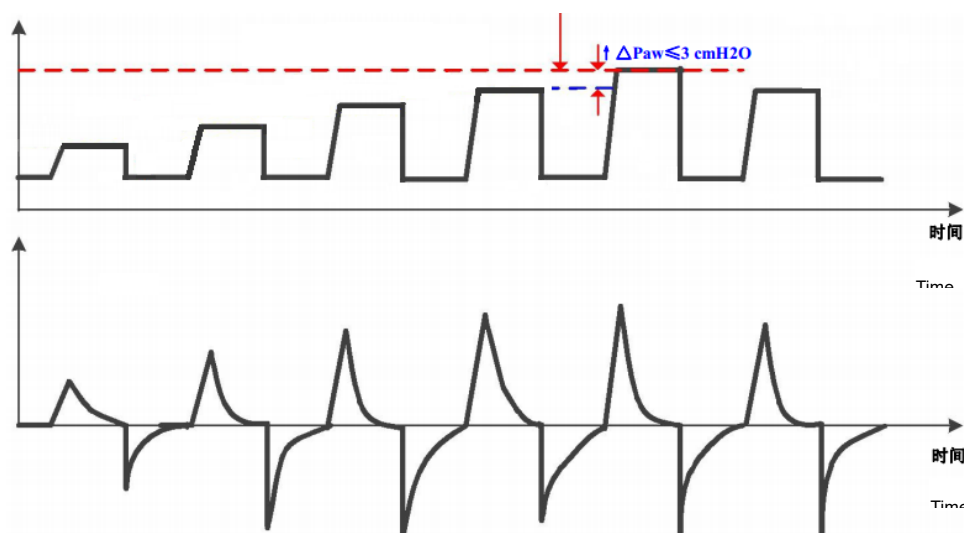

Fig. 7-15 PRVC mode controlled typical pressure and velocity waveforms

7.6.10. PRVC-SIMV

The PRVC-SIMV mode is known as the pressure-regulated volume control-synchronous intermittent mandatory ventilation mode, and is a ventilation mode that ensures the lowest preset ventilation frequency. The mechanical ventilation mode provided is the

volume mode (PRVC mode). The SIMV is triggered within the trigger window to supply the volume control ventilation once. If a trigger window has not been triggered at the end of the trigger window, the volume control ventilation is also provided once. The trigger window is used for autonomous or pressure support respiration.

The typical pressure waveforms controlled by PRVC-SIMV mode are as shown below:

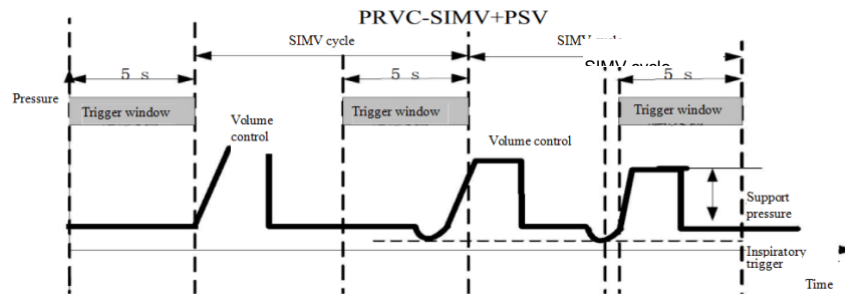

Fig. 7-16 PRVC-SIMV mode controlled typical pressure waveform

7.6.11. CPAP

CPAP mode is known as the nasal continuous positive airway pressure mode: in this mode, continuous positive airway pressure is provided through the nasal interface (nasal catheter or nasal mask), and respiration frequency and tidal volume of the patient are determined by the patient himself.

The typical pressure and flow velocity waveforms controlled by CPAP mode are as shown below:

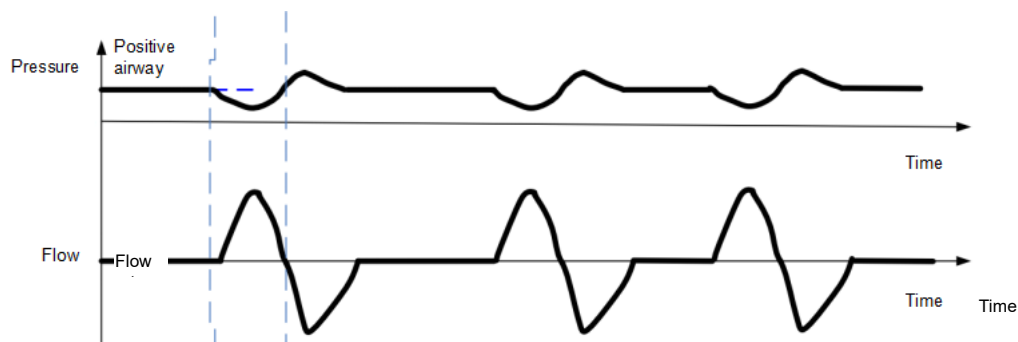

Fig. 7-17 CPAP mode controlled typical pressure and flow velocity waveform

7.6.12. HFNC

HFNC is the high flow oxygen therapy function. This mode is indicated for the patient who has autonomous respiration. Enter HFNC Mode:

1 . Before starting ventilation, click the [HFNC] button in the patient setting screen to start HFNC ventilation and timing. After clicking the [suspend] button, HFNC will suspend ventilation and timing; then after clicking the [Start] button, HFNC will resume ventilation and timing.

2 . In other modes, click the [Standby] button to enter the patient setting screen, and

click the [HFNC] button to start HFNC ventilation.

3 . You can set parameters in HFNC mode: oxygen inhalation flow rate/oxygen concentration/pressure upper limit.

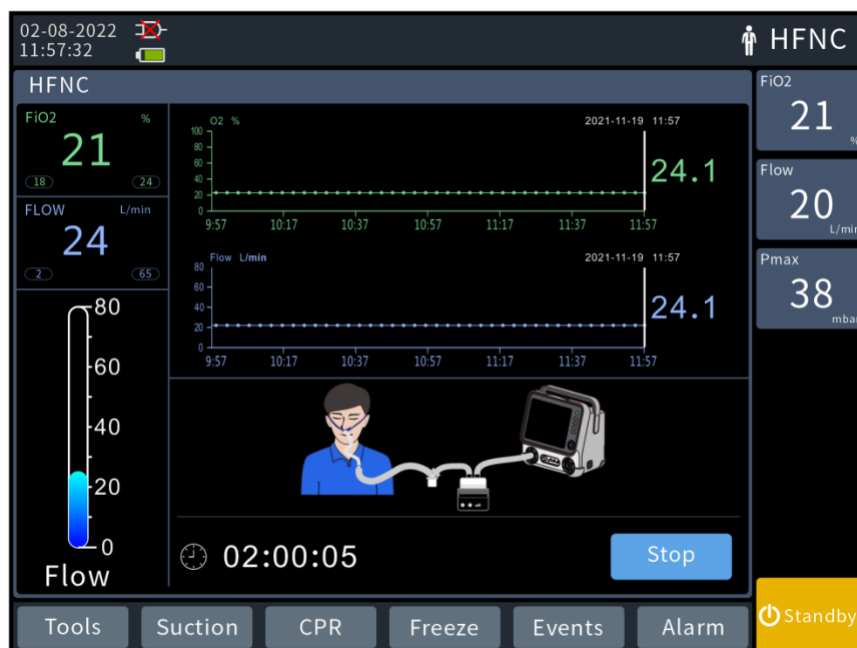

Fig. 7-18 HFNC interface



Caution:

- HFNC can only be used for the patients with autonomous respiration.
- Patients must be given oxygen therapy under the supervision of medical care professional. If something goes wrong or the patient does not have enough autonomous respiration, the medical care professional can help immediately.
- Only the inhaled oxygen concentration and oxygen flow rate are monitored during oxygen inhalation.
- Oxygen shall be inhaled only with an oxygen mask or nasal catheter, not with a NIV mask. Improper use of mask may be dangerous for patients.

7.6.13. Apnea ventilation

It is also known as the standby ventilation mode, and is a standby ventilation mode that is enabled when the system detects apnea in the patient. When apnea ventilation is enabled, the pressure control mode or volume control mode can be selected, and apnea ventilation parameters can be set. Apnea ventilation can only be disabled if autonomous respiration of the patient is detected, the ventilation mode is switched, or the apnea ventilation switch is turned off.

7.6.14. Sigh

Sigh function can prevent lung collapse and help reopening of collapsed alveoli. To turn

on the sigh function, you can select [Sigh] in the current ventilation mode parameter setting interface, and you can choose to turn on/off the sigh function.

Sigh function setting:

1 . You can activate the pressure sigh function in the Pressure Control mode. Once you activate the Pressure Sigh function, PEEP intermittently increases the preset [Sigh Pressure]. [Sigh Count] means the periodic interval of sighing.

2 . You can pneumatically activate the tidal volume sigh function in the volume control mode. Once you activate the tidal volume sigh, the preset [Sigh Tidal Volume(VT)] will be provided intermittently. [Sigh Count] means the periodic interval of sighing.



Notices:

The sigh function is not available in BIPPV and APRV modes.

7.6.15. Intubation/Automatic tube compensation

Intubation/Automatic tube compensation is to select endotracheal intubation or tracheotomy intubation with different aperture for different users. The ventilator can automatically adjust the gas supply pressure so that the pressure at intubation end is as consistent as possible with set value of the ventilator pressure.

Once you select the ventilation mode, select [Compensate] → [ATC] in the parameter setting screen. When it is activated, you can perform corresponding parameter setting. After clicking [Save] button, the system will activate the intubation Compensation function; after clicking the [Close] button, the system will stop the intubation compensation function during ventilation immediately.



Notices:

Automatic tube compensation may result in automatic triggering. If automatic triggering occurs, first check the patient, respiratory circuit, and other possible causes.

7.6.16. Compliance compensation

Compliance compensation refers to the self inspection of machine in which the ventilator detects and determines the compliance of respiratory line , and compensates for the effect of line compliance in the form of volume during ventilation.

After selecting the ventilation mode, select [Compensate] → [Tube Comp.] in the parameter setting interface; Click [Start], and the system will automatically perform the compliance compensation, then after clicking [Close] button, the system will immediately stop the compliance compensation function during ventilation process.

7.7. Standby

Select the [Standby] key and confirm to enter the standby interface.

! Notices:

1 . In order to prevent patients from being injured due to lack of ventilation support, it is necessary to ensure that alternative ventilation is available before entering to standby mode and ensure that no patient is connected to the ventilator at the time of entering in standby.

2 . In order to prevent the patient from being injured or the respiratory line from being damaged by overheating of gas, the humidifier should be turned off when it enters standby.

7.8. End ventilation

Click the [ON/OFF] button in the standby state to turn off the mainframe.

! Caution:

Do not use up the oxygen cylinder completely. It is always necessary to ensure that there is residual gas pressure in the cylinder when you return it to refill, which will prevent moist/humid air in the surrounding environment from intruding and causing corrosion/rust.

1 . Please check the barometer on the pressure reducing valve that shows the pressure of the cylinder to check the gas storage condition of the cylinder. If the barometer indicates less than 5MPa (including 5MPa, about 725PSI), the oxygen cylinder must be replaced with a new one.

2 . The outlet valve on the oxygen cylinder shall be closed.

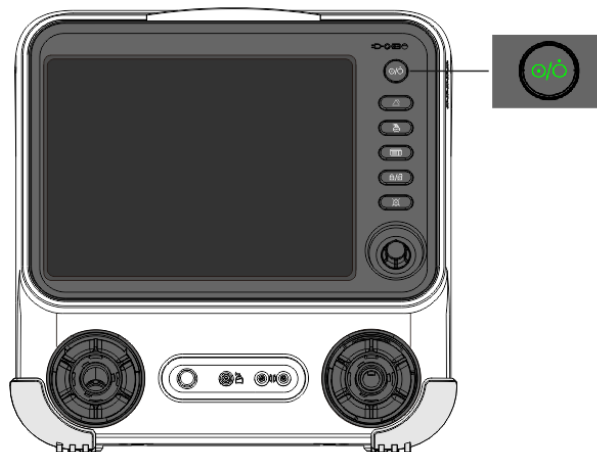

Fig. 7-19 Shutdown of ventilator

7.9. Oxygen consumption

7.9.1. Oxygen consumption

When connected to high pressure oxygen supply, the machine automatically calculates the oxygen consumption and displays it on the Parameters Monitor screen: O2 con. in L.

Oxygen consumption is a cumulative value.



Notices:

- A valid calculation value is only displayed when the high pressure oxygen supply is connected.
- This parameter is automatically zeroed after shutdown and restart.

7.9.2. Oxygen consumption zeroing

1 . In Standby interface, Click on  → [Maintenance] → [User Maintenance] → [O2 consumption clear].

2 . After clicking [Clear] the system will automatically zero the current oxygen consumption and automatically re-accumulate after the next high pressure oxygen supply is connected.

7.10. Data Export

This machine provides the patient data export function, you can use it to export the current patient's log information and trend information, etc.

1 . Insert the USB drive into the USB port of the ventilator.

2 . Click  → [Maintenance] → [User Maintenance] → [Data Export] in Standby screen

3 . If the export is successful, it will display a successful information, if the export fails, it will display "Export Fails".



Notices:

To check the export information, please contact our after-sales department.

8. CO2 monitoring

8.1. Overview

The CO2 module of this ventilator uses infrared absorption technology to measure the CO2 concentration in patient's respiratory line. The principle is based on the fact that CO2 molecules can absorb infrared light energy of a specific wavelength, and the amount of energy absorbed is directly related to the concentration of CO2. Part of the energy will be absorbed by the CO2 in the gas when the infrared light emitted by the infrared light source penetrates the gas sample containing CO2. The remaining infrared light energy is measured by the photoelectric detector on the other side of the infrared light source, and is converted into an electrical signal. The electrical signal is compared with energy of the infrared light source and adjusted to accurately reflect the CO2 concentration in gas sample.

The CO2 module product is not the only method designed to monitor patients. This device shall always be used in conjunction with other vital signs monitoring devices and/or in conjunction with the individual judgment of a professional to determine the patient's condition. The product is designed to be used only by trained and authorized medical professionals.

CO2 measurement provides:

- 1 . CO2 waveform.
- 2 . End expiratory CO2 concentration (ETCO2): Concentration of CO2 measured at the end of the expiratory stage.
- 3 . V-CO2 curve

Monitored parameters:

- V_{daw} : airway dead cavity.
- V_{Daw}/T_{ve} : ratio of airway dead cavity to tidal volume.
- V_{talv} : alveolar ventilation volume.
- V'_{alv} : minute alveolar ventilation.
- SlopeCO2: CO2 rising slope.
- V'_{CO2} : CO2 emission rate.
- V_{eCO2} : volume of CO2 exhaled.
- V_{iCO2} : volume of CO2 inhaled.

8.2. CO₂ monitoring setting

- 1 . Connect the sensor to CO₂ module.
- 2 . The CO₂ module is the measurement mode by default. After connecting the CO₂ module, the machine will automatically start CO₂ monitoring.
- 3 . The zeroing calibration operation shall be carried out as described in Section 8.4 (EtCO₂ zero calibration).
- 4 . Once you complete zeroing, connect the gas circuit properly.
- 5 . The measurements can be started after confirming air tightness of the gas line.



Notices:

- CO₂ cannot be measured in the environment of aerosol drugs, so the CO₂ module should be removed and the nebulization function should be activated.
- Please ensure that the patient's cardiopulmonary state is stable in order to obtain the most accurate CO₂ measurement results.

8.3. Measurement influencing factors

The following factors may affect the accuracy of the measurement:

- Leakage or internal leakage of sampled gas;
- Mechanical shock;
- Circulating pressure greater than 10 kPa (100 cmH₂O);
- Other sources of interference (if any).

8.4. EtCO₂ zero calibration

To ensure accuracy of monitoring parameters, the module should be zeroed before CO₂ monitoring. The zero calibration steps are as follows:

- 1 . Connect CO₂ monitoring module correctly, and click the  soft key → [Maintenance] → [User maintenance] → [EtCO₂ zero calibration] → [Start]
- 2 . If the zero calibration passes, the system will display a prompt message: [Passed]. Otherwise, [Fail] will be displayed and zero calibration needs to be performed again at this time.

9. Cleaning and disinfection

The ICV mainframe and its accessories must be cleaned and disinfected after each use to keep it in a good standby state, to avoid cross-infection. Functional inspection should be carried out after each cleaning and disinfection (see the "11 Maintenance and inspection" section).

9.1. ICV mainframe

The mainframe shall be simply wiped and cleaned with a piece of soft rag wet in water-soluble disinfectant.

When cleaning the ventilator, be sure to prevent the disinfectant from entering into the ventilator. Do not use any organic solvents to clean the surface of the machine.

The whole machine can be sterilized by ultraviolet light with the irradiation disinfection duration of 1 hour.



Caution:

- 1 . When disinfecting the whole machine, fumigating with peracetic acid and formaldehyde is forbidden.
- 2 . The disinfectants shall be prepared according to instructions of the manufacturer.

9.2. Respiratory line components

If the respiratory line assembly is supplied by Gradian Health Systems, please follow the instructions described below. If it is purchased separately from another manufacturer, cleaning and disinfection should be done as per the instructions provided by the manufacturer.

9.3. Parts and accessories

The mask and all silicone parts must be cleaned and disinfected with disinfectant:

- 1 . The whole inner and outer surface of the spare part must be wet and free of any air bubbles. These parts can be disinfected for the maximum time limit specified by the supplier of the disinfectant which is used.
- 2 . After disinfection, please clean the parts with distilled water to prevent the residue of disinfectant causing problems to the machine or the patient.
- 3 . Place all silica gel parts in dry air and let them dry naturally.
- 4 . Check the mask and replace it immediately if there are any damaged parts.

5 . Re-useable respiratory hoses, patient respiratory valves, silicon parts and respiratory masks can also be sterilized/disinfected with high temperature.

9.4. Valve accessories

Warning:

Risk of explosion! It is strictly forbidden to put valve accessories (pressure reducing valves, oxygen cylinders, etc.) in disinfectants or other similar liquids. Only wiping and disinfecting is allowed. Never let the liquid to flow into the pressure reducing valve, otherwise it will cause an explosion.

If it is really necessary to disinfect the pressure reducing valve and the supporting oxygen cylinder, please wipe with a piece of clean soft cloth. The soft cloth can be used as dry or moistened with clean water.

9.5. Replacement of filter cotton

Steps to replace filter cotton (as shown below):

- 1 . Open the rear cover ②;
- 2 . Take out the old filter cotton ①;
- 3 . Wipe the filter chamber clean with a medical cotton ball wetwith alcohol;
- 4 . Put the new filter cotton into the filter cartridge.

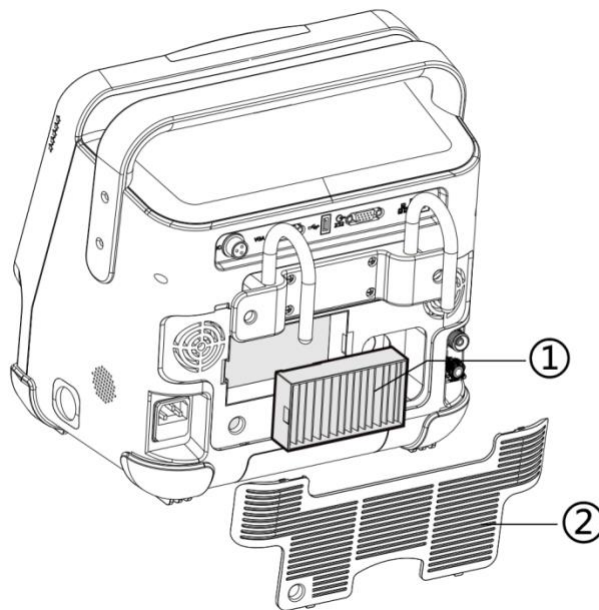

Fig. 9-1 Replacement of filter cotton

Warning:

Use of the ventilator without a filter shall be prohibited, in order to avoid affecting performance of the machine, or even cause damage to the machine.

9.6. Handling method

Parts	Cleaning	Disinfection	Rinsing in a washer	Sterilization
ICV	Use a piece of dry or wet wiping rag	Wipe to disinfect	Not allowed	Not allowed
Patient breather valve	In warm water with mild household detergent	Immerse in a diluted solution until all surfaces are wetted inside and outside without any bubbles. The immersion time should be sufficient enough. After disinfection, thoroughly rinse the inside and outside of all parts with distilled water, and then let them dry.	Rinsing shall be carried out below 93°C (heat disinfection in automatic cleaning machine)	Boiled water steaming
Reusable respiratory mask				The hot steam sterilization shall be conducted at 134°C by using a device specified in EN 285 for a retention time of 5 minutes.
Reusable respiratory hose				
Oxygen valve accessories	Use a piece of dry or wet wiping rag	Wipe to disinfect	Not allowed	Not allowed

Cleaning and disinfection solution can be used	
Medical alcohol(75%)	Disinfectant
Isopropyl alcohol	Disinfectant
glutaraldehyde	Disinfectant
Phthalaldehyde disinfectant	Disinfectant

Soap water(pH from 7.0 to 10.5)	Detergent
clean water	Detergent

10. Faults and troubleshooting methods

If any fault occurs and cannot be removed, please contact the manufacturer, Gradian Health Systems, or the dealer authorized by Gradian Health Systems. It is prohibited to continue using the machine to avoid unnecessary injuries.

10.1. Technical faults

Faults	Causes	Remedies
ICV cannot be started	ICV malfunction/fault	Deliver to the manufacturer or seller for repair
	The battery is used up	Recharge the battery
Obvious oxygen loss	The gas supply line leakage	Identify and correct gas leakage points
ICV cannot be shut down	Operational error	Press and hold the "ON/OFF" key for at least 3 seconds
The power indicator flashes on and off	The power plug is loose	Reconnect firmly
The working time is short when the battery is used to supply power.	Service life of battery expires	Use a new battery

10.2. Physiological alarm

Messages	Alarm	Causes	Remedies
Minute ventilation is high	Minute ventilation is high	The set upper limit of minute ventilation is exceeded	Check the patient's condition Check if the set upper limit is reasonable or not
Minute ventilation is low	Minute ventilation is low	It is below the set lower limit of minute ventilation	Check the patient's condition Check if the set lower limit is reasonable or not
apnea	apnea	The apnea time exceeds the set	Check condition of the patient

		time value	Check that the set time value is reasonable or not
Airway pressure is high	Airway pressure is high	The set upper limit is exceeded	Check condition of the patient
		Airway obstruction	Check condition of the patient
		Respiratory hose is misplaced	Put the respiratory hose in place
		Pmax is set too low	Correct the Pmax
		Respiratory hose is twisted	Check position of patient and move to an appropriate position if necessary

10.3. System alarms

Messages	Alarm	Causes	Remedies
Gas source pressure is insufficient	The gas source pressure is less than 2.5 bar	The cylinder is not opened, or the gas in the cylinder is fully used up	Open the oxygen cylinder or replace with a full cylinder
		The compressed gas source is defective	Replace with a gas source which is in good conditions
		Gas supply connection line of ventilator is twisted or compressed	organize the ventilator gas connection line or remove the items compressed in the ventilator gas connection line
		The pressure reducing valve is defective	Replace the pressure reducing valve
The respiratory line is	The respiratory line is	1.The respiratory hose leaks/slides off. 2.The respiratory	Check the connections

detached!!!	detached!!!	mask is not properly worn. 3.The pressure measurement hose leaks/slides off.	
		Systematic fault	Repair
Low battery level	Low battery level	The battery power is too low	Recharge the battery

10.4. Abnormal power failure alarms

ICV has the function of shutdown alarm caused by abnormal power failure of the system.

The alarm will be triggered when the mainframe is shut down due to the power failure caused by any abnormality, and the alarm duration is not less than 15 seconds;

This alarm can be canceled by clicking the lock screen key.

11. Maintenance and inspection

11.1. Routine inspections

Before each use:

Functional inspection shall be carried out once.

After each use:

The reusable respiratory hoses and patient respiratory valves must be cleaned and disinfected once according to the instructions for use in Chapter 6.

After each use or removal:

The device and its components shall be cleaned, disinfected or sterilized (see "9 Cleaning and disinfection");

After each maintenance, remember to conduct a safety inspection, and the ventilator must be regularly inspected and maintained.

Every six months:

The filter cotton must be replaced. Please refer to "11.14 Replacement of filter cotton" for the replacement method.

Every two years:

The device must be cleaned, disinfected and inspected for safety in accordance with the instructions for use in Chapter 6. In addition, it should be maintained by the manufacturer or its authorized professionals.

Every three years:

The oxygen valve accessories (e.g., pressure reducing valve) shall be repaired by the manufacturer or its authorized professional.

If it is not used during this period:

The functional inspection shall be carried out at intervals not exceeding than six months.

11.2. Check air tightness of the system

1 . Please slowly open valve of the oxygen cylinder. The cylinder pressure can now be checked on pressure gauge of the pressure reducing valve. For example, a 2,000 psi reading means the gas in cylinder is sufficient, and a 1,000 psi reading means the cylinder is only half full. For example, when the pressure is less than 725psi, the oxygen cylinder shall be replaced in time to ensure sufficient working time.

2 . Close the oxygen cylinder valve again.

3 . The gauge pointer on the pressure reducing valve shall be observed for approximately one minute. If position of the pointer remains the same, the system is air-tight. If the pointer drops continuously, there is a leakage.

Exclude the causes of leakage:

-
- 1 . Prepare an aqueous soap solution from fragrance-free soap.
 - 2 . Wet all threaded connectors/joints and hose fittings with this solution. The place where bubbles appear is the leakage point.
 - 3 . Relieve pressure from the system: for this, it is necessary to close the oxygen cylinder. Turn on ICV for a while until reading of pressure gauge of the oxygen cylinder is "0". Then turn ICV off again.
 - 4 . If there is any leakage, replace the damaged parts.
 - 5 . Then check the air tightness again.
 - 6 . If the cause of leakage cannot be identified, it must be repaired.

11.3. Check patient respiratory valve

- 1 . Open the patient respiratory valve.
- 2 . Visually check the surface of all spare parts for cracks or other mechanical damages. The one-way diaphragms (two in total) that have become corrugated, twisted and sticky must be replaced. The one-way diaphragms do not need to be replaced during inspection. However, the one-way diaphragms that have become corrugated, twisted and sticky must be replaced, or they may cause serious failure.
- 3 . Reinstall the patient respiratory valve.



Notices:

During installation, it is necessary to note that either the one-way diaphragms are in the correct position or not.

11.4. Functional inspection of machine

In addition to the above inspections, the ventilator shall also be powered on to operate by the medical staff who is specially responsible for management of the machine to conduct simple functional inspection and confirm that the machine is free from faults before it is connected to the patient for use.

The steps for functional inspection are as follows:



Warning:

If any problems are found during the inspection, it must not be used for patients!

- 1 . Connect the power supply and gas source, and check whether the power supply and gas source are normal.
- 2 . Power-on self-inspection. After the ventilator is started, the system will start the power-on self-inspection. It is mainly to check if each sensor works normally.

3 . Inspection of respiratory apnea alarm. The specific steps are as follows:

- a. Set the alarm time of respiratory apnea to 15s.
- b. Set the respiratory mode as CPAP/PSV, count time at the same, record the time when the ventilator gives a respiratory apnea alarm, and compare it with the set value. The test time value should be 13s-17s.

4 . Inspection of airway pressure upper limit alarm function. The specific steps are as follows:

- a. The ventilator is set to V-A/C ventilation mode.
- b. VT is set to 600ml, I:E is set to 1:2, and FREQ is set to 10.
- c. Pmax is set to 20mbar.
- d. When the patient's gas vent of the patient's expiratory valve is blocked by hand until the airway pressure is higher than 20mbar, an audible and visual alarm of high airway pressure shall be generated. The alarm shall be canceled about 10S after releasing the hand.

5 . Inspection of respiratory system integrity alarm function. The specific steps are as follows:

- a. The ventilator is set to A/C ventilation mode.
- b. VT is set to 600ml, I:E is set to 1:2, FREQ is set to 10, and PMAX is set to 30mbar.
- c. If patient end of the line is not connected to the simulated lung, the system shall generate an audible and visual (disconnected) alarm after two respiratory cycles. When the simulated lung is connected, the alarm shall be canceled.

6 . Inspection of low battery power alarm function. The specific steps are as follows:

When ICV is connected for self-inspection, the low battery power alarm will be inspected automatically. If ICV works normally and no alarm is given after the ICV is powered on when the oxygen cylinder is opened, it shows that the voltage is normal.

7 . Trigger pressure function test. The specific steps are as follows:

- a. The ventilation mode is set to CPAP/PSV ventilation mode, and CPAP pressure is set to 0.
- b. The trigger pressure is set to -3mbar.
- c. Inhale through the mask. The ventilator shall supply gas when the inspiratory negative pressure reaches to -3mbar, and will stop supplying gas when the support pressure reaches to the target pressure. Wait for next triggering of ventilation.

11.5. Touch screen calibration

When the touch screen does not work correctly, the user can calibrate the touch screen as follows:

Enter the standby mode, click the  soft key to enter [Maintenance] → [User maintenance] → [Calibrate TP (touch panel)]; complete calibration of the first point in the lower left corner and the second point in the upper right corner successively to complete calibration of the touch screen.

11.6. Oxygen concentration calibration

Oxygen concentration calibration shall be carried out if oxygen concentration monitoring value error is large or after replacing the oxygen sensor. Oxygen concentration can be calibrated according to following steps:

- 1 . Ensure that the high-pressure oxygen source is connected.
- 2 . Enter the standby mode, click the  soft key to enter [Maintenance] → [User maintenance] → [FiO2] → [Start]
- 3 . If the calibration successes, the system will display a prompt message: Calibration is [successful]. Otherwise, it shows that the calibration [failed], and it needs to be re-calibrated at this time.

 **Notices :**

To ensure accuracy, please ventilate normally at 21% oxygen concentration for 1-3 minutes before performing oxygen concentration calibration.

11.7. Flow sensor calibration

Calibration of flow sensor shall be carried out when error of flow monitoring value is large or the flow sensor is replaced. Calibration of flow sensor can be performed according to the following steps:

- 1 . Connect respiratory line and flow sensor.
- 2 . After powering on, enter the calibration interface or standby interface, click the software key, enter [maintenance] → [user maintenance] → [flow sensor] → [start], then reverse the flow sensor according to the interface prompt, click [start] again, and then connect the flow sensor according to the interface prompt.
- 3 . If the calibration is successful, the system will display a prompt message: Calibration is [successful]. Otherwise, it shows that the calibration [failed], and it needs to be re-calibrated at this time.

11.8. Hose compliance

Compliance calibration of the line shall be carried out when replacing the respiratory line and the external accessories related to the connection between the ventilator and respiratory line. Calibration of line compliance can be performed according to the following steps:

- 1 . Connect the respiratory line.
- 2 . After starting the machine, enter the calibration interface and insert the Y-shaped connector into the leak detection plug according to the prompts on the interface, so that the respiratory line is air-tight.
- 3 . In the standby interface, select [System calibration] → [Hose Compliance] → [Start] key.
- 4 . If the calibration is successful, the system will display a prompt message: Calibration is [successful]. Otherwise, it shows that the calibration [failed], and it needs to be re-calibrated at this time.

11.9. Hose resistance

When replacing the respiratory ducts and the external accessories related to the connection between the ventilator and respiratory ducts, perform a hose resistance calibration,. Hose resistance calibration can be performed according to the following steps:

- 1 . Connect the respiratory duct/line.
- 2 . From the standby interface, select [System calibration] → [Hose resistance] → [Start] key.

3 . If the calibration successes, the system will display a prompt message: [Calibration is successful]. Otherwise, it shows that the calibration failed, and it needs to be re-calibrated at this time.

11.10. Gas line zero calibration

In the standby interface, select [System calibration] → [Gas line zero calibration] → [Start]

If the zero calibration successes, the system will display a prompt message: [Complete]. Otherwise, [Fail] will be displayed and zero calibration shall be carried out again at this time.



Notices:

During the zero calibration process, the patient or any device that generates flow should not be connected to the ventilator ICV.

11.11. Gas line self-check

In the standby interface, select [System calibration] → [Gas line Self-check] → [Start]

If the self-Check passes, the system will display a prompt message: [Pass]. Otherwise, [Fail] will be displayed and self-inspection shall be carried out again at this time.

11.12. Battery management

The ICV is equipped with a rechargeable lithium-ion battery, which is powered by a built-in battery through the ICV mainframe. The charging time shall not be less than 8 hours, and the working time under standard conditions shall not be less than 6 hours after full charging. It is recommended to charge it fully at intervals (every 6-12 months, depending on how long it is used) before running it down completely.

11.12.1. Battery inspection

To check battery performance, please refer to the following:

- 1 . Disconnect the ventilator from the patient and turn it off .
- 2 . Connect the ventilator to the external power supply, and charge the battery continuously for more than 10 hours.
- 3 . Disconnect the external power supply and use the battery to power the ventilator until the ventilator is turned off.
- 4 . Duration of battery power supply reflects performance of the battery.
- 5 . If power supply duration of the battery is significantly lower than the time stated in the specification, consider replacing the battery or contacting the maintenance personnel.

11.12.2. Battery storage

When the battery is stored, make sure that electrodes of the battery do not come into contact with any metal objects. If long-term storage of the battery is necessary, it shall be kept in a cool environment and make sure that power of the battery is kept at 40% to 60%. Storing the battery in a cool environment can slow down aging of the battery. Ideally, the battery shall be stored in a cool environment at 15 °C (60 °F). The battery shall not be stored in an environment outside the range of -20°C (-4°F) to 60°C (140°F).

If the ventilator will not be used for a long period of time, the battery shall be taken out, or the battery will be over-discharged and the charging time will be significantly prolonged. The stored battery shall be charged incompletely every 2 months to maintain a power of 40%-60%. The battery shall be fully charged before use.

11.12.3. Battery replacement

- 1 . Make sure the ICV mainframe is in shutdown state;
- 2 . Open the battery lock in the direction of the arrow;
- 3 . Remove the dead battery from battery case (see Fig.11-1);
- 4 . When installing a fully charged battery, push the battery by hand after loading until a “click” indicating that the battery key is reset is heard, in order to ensure that the battery has been installed in place.

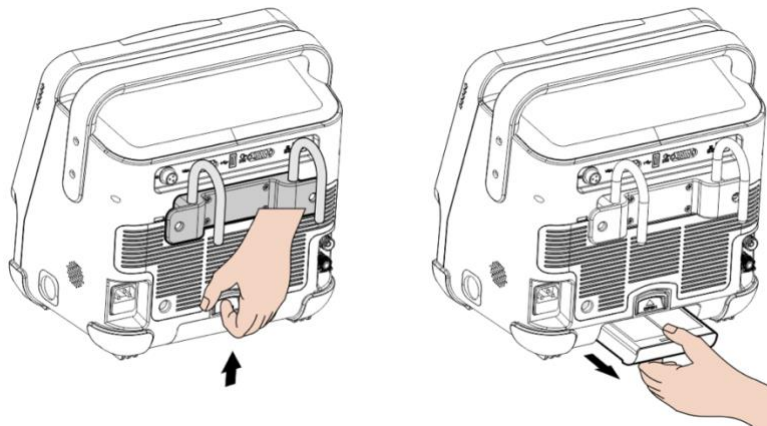

Fig. 11-1 Opening the battery lock and taking out the battery

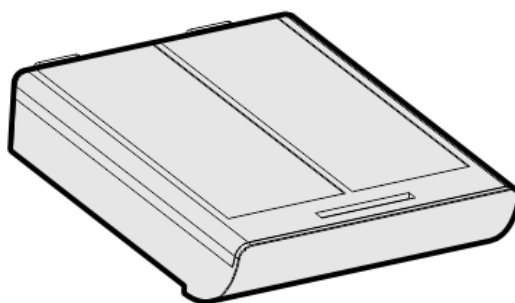

Fig. 11-2 Placement with a new battery

11.12.4. Battery status description

The user can view whether the battery is connected, whether the battery is charging, the battery power and other information in the interface. Status of the battery is described as follows:







Components	Description
1 	The battery is not connected
2 	20% power
3 	40% power
4 	60% power
5 	80% power
6 	100% power

Fig. 11-3 Battery status

If the battery indicator flashes, it indicates that the battery is charging. The battery indicator is always on, indicating that the battery has been connected; the battery indicator is off, indicating that the battery is not connected or the battery runs out of power; and, the battery indicator flashes, indicating that the battery is charging.

 **Warning:**

If any problems are found during the inspection, it must not be used for patients!

- 1 . The battery specified by Gradian Health Systems must be used, otherwise the machine may not work normally.
- 2 . The battery life is about 10,000 hours.
- 3 . Short-circuit of battery is prohibited;

-
- 4 . Never heat or burn the battery;
 - 5 . Avoid using the battery near any heat sources;
 - 6 . Never wet the battery;
 - 7 . Avoid charging in the vicinity of fire or in direct sunlight;
 - 8 . Use a specified charger and charge properly;
 - 9 . Do not mix with other batteries;
 - 10 . Keep the battery away from children;
 - 11 . Do not place it on the charger for a long period of time;
 - 12 . The leaky battery shall not be kept close to the fire;
 - 13 . Avoid using the battery in strong sunlight.

11.13. Accessories

For maintenance cycle and maintenance application of each accessory of ICV, please refer to operating instructions of each accessory.

Oxygen cylinders must be rechecked in accordance with the proper rules. Expiration date of the oxygen cylinder can be found on the label attached to the cylinder.

11.14. Storage

If ICV is not used for a long period of time, following measures are recommended:

- 1 . Clean and disinfect (see Section 9 "Cleaning and disinfection").
- 2 . Store in a dry place.
- 3 . The battery can be retained in the device during long-term storage.



Important:

The stored device must comply with the maintenance period and must not be taken out from the warehouse for direct use.

11.15. Disposal of abandoned device

The abandoned device shall be sent to a qualified waste electrical appliance disposer for disposal.

12. ICV accessories

S/N	Name/model	Function	Manufacturer	Remarks
1	Mainstream carbon dioxide module M401B	Support CO ₂ gas monitoring	Witleaf	Purchased part



Notices:

- The accessories listed in this section are applicable to the ventilator. The hospital shall be responsible for ensuring the compatibility between ventilator and accessories. Incompatibility between the ventilator and accessories may reduce performance of the ventilator.

- The specific configuration is subject to the packing list.

13. Product specifications

13.1. Safety specifications

Medical device management category	
Category	Category III medical devices
Electric shock protection type	Category I device, including internal power supply
Electric shock protection class	Defibrillation-proof BF type
Operating mode	Continuous operation
Degree of safety for flammable anesthetic gas	It shall not be used in the presence of flammable anesthetic gas mixed with air or with oxygen or nitrous oxide
Liquid entering protection grade	IP43
Installation and use classification	Mobile equipment

13.2. Physical specifications

Overall dimensions	
size	H*W*D: 300mm*305mm*210mm (Main Unit) H*W*D: 1050mm*510mm*650mm (trolley)
Weight (with battery)	Approximately 6.2kg (Mainframe) Approximately 19.5kg (trolley)
Display screen	
Type	Color screen TFT
Size	10.4 inches.
Resolution	1024 * 768 pixels
Function	With touch screen
Interface	
Network interface	Support to connect to PC for software upgrade function

USB interface	Software of the ventilator can be upgraded via USB port, configuration information and historical data (e.g., trend data, logs, etc.) can also be exported via USB port, and configuration can be transferred between the machines with the same model via USB flash disk drive.
RS-232 interface	It can be connected to medical grade external devices for communication between the ventilator and these external devices.
VGA interface	Output the same VGA video signal and content as the main display, used to connect the external display (support 1280*800 resolution display)

13.3. Environmental specifications

	Temperature	Air pressure	Relative humidity
Working	-10°C-50°C	62kPa ~ 110kPa	10%~95%
Storage	-20°C - 60°C (oxygen battery: -20°C - 50°C)	50kPa ~ 110kPa	10%-95% (non-condensation)

13.4. Power supply specifications

External AC power supply	
Input voltage	AC 100-240V
Input frequency	50/60Hz
Input current	<2A
External DC power supply	
Input voltage	DC 12V
Total power	≤140VA
Battery in mainframe	
Battery type	Lithium-ion battery
Battery capacity	9600mAh
Rated battery voltage	DC 14.8V
Minimum power supply time	6h (a new fully charged battery operated in standard operating conditions)

13.5. Gas supply specifications

Gas supply specifications	
Gas supply	Medical oxygen
High-pressure gas source pressure	3.0-6.0 bar
High-pressure pipe input connector	DISS connector
Low-pressure gas source pressure	The flow rate is not greater than 8L/min
Low-pressure pipe input connector	CPC quick connector
Inspiratory module	
Peak flow rate	≥200L/min
Nebulizer interface	Outer diameter 6.5mm
Inspiratory branch external interface	Outer diameter 22mm
Expiratory module	
Expiratory branch external interface	Outer diameter 22mm
Resistance	
Inspiratory resistance	No more than 6 cmH ₂ O (adult) at a flow rate of 60 L/min; No more than 6 cmH ₂ O (pediatric) at a flow rate of 30 L/min; No more than 6 cmH ₂ O (infant) at a flow rate of 5 L/min;
Expiratory pressure	No more than 6 cmH ₂ O (adult) at a flow rate of 60 L/min; No more than 6 cmH ₂ O (pediatric) at a flow rate of 30 L/min; No more than 6 cmH ₂ O (infant) at a flow rate of 5 L/min;
Trigger mode	

Trigger mode	Pressure trigger, flow trigger
Mechanical safety valve	
Mechanical safety valve	≤ 110 cmH ₂ O

13.6. Parameter specification

Control parameters	Range	Accuracy
Respiratory rate	Infant: 0,1 ~ 150bpm Adult/Pediatric: 0,1 ~ 100bpm	Error: ±1bpm (0-100bpm); ±5% of set value (above 100bpm)
Inspiratory time	0.20-10S	Error: ±0.1s or ±10% of the set value, whichever is greater
Tidal volume	Adult: 100 ~ 2000mL Pediatric: 20 ~ 300mL Infant: 2 ~ 100mL	± (10 mL + 10% of the setting value) (pediatric/adult mode); ± (1.5 mL + 15% of the setting value) (infant mode); ;
Oxygen concentration	21%-100%	± (3 vol.%+ 1% of set value) While 500ml, 21%-90% response time : 140s; While 150ml, 21%-90% response time : 160s; While 30ml, 21%-90% response time : 220s
Inspiratory pressure	1-90cmH ₂ O	± (0.9 cmH ₂ O + 10% of the setting value)
I:E	4 : 1 ~ 1 : 10	2:1 ~ 1:4 : ±10% of set value ; Others : ±15% of set value
Upper pressure limit	10-100 cmH ₂ O	± (2cmH ₂ O+ 5% of set value)
Pressure trigger	-20 ~ -0.5 cmH ₂ O	± (0.4 cmH ₂ O + 10% of the setting

		value)
Positive end expiratory pressure	0-40cmH ₂ O	± (0.9cmH ₂ O + 5% of the setting value)
Pressure support	Closed, 1-90cmH ₂ O	± (0.9cmH ₂ O + 5% of the setting value)
Flow trigger	Infant:0.2 ~ 5.0L/min Adult/Pediatric:0.5~20 .0L/min	± (0.1 L/min + 10% of the setting value) (infant mode); ± (0.4 L/min + 10% of the setting value) (adult/pediatric mode)
Pressure rise time	0.6s-2s	± (0.05s + 20% of the setting value)
Sensitivity of expiratory trigger	5%-85 %	± 5% (absolute error)
Oxygen therapy flow	Adult: 2 ~ 65 L/min Pediatric: 2 ~ 25 L/min infant: 2 ~ 20 L/min	± 2 L/min or ± 15%, whichever is greater
High-level pressure	1-90cmH ₂ O	± (2cmH ₂ O+ 5% of set value)
Low-level pressure	0-40cmH ₂ O	± (2cmH ₂ O+ 5% of set value)
High-level pressure time	0.2-30s	Error: ±0.1s or ±10% of the set value, whichever is greater
Low-level pressure time	0.2-30s	Error: ±0.1s or ±10% of the set value, whichever is greater
Apnea	5-60s	Error: ±0.1s or ±10% of the set value, whichever is greater
Inspiratory pause	0%-60%	
Monitored parameters		
Respiratory rate	0 ~ 250bpm	±2bpm or ±5% of actual reading,

		whichever is greater
Inspiratory tidal volume	0-3,000ml	$\pm (2\text{mL} + 15\% \text{ of actual reading})$ (infant mode); $\pm (3\text{mL} + 15\% \text{ of actual reading})$ (pediatric mode); $\pm 15\%$ of actual reading (adult mode)
Expiratory tidal volume	0-3,000ml	$\pm (2\text{mL} + 15\% \text{ of actual reading})$ (infant mode); $\pm (3\text{mL} + 15\% \text{ of actual reading})$ (pediatric mode); $\pm 15\%$ of actual reading (adult mode)
Minute volume	0-100L/min	$\pm (0.4\text{L/min} + 15\% \text{ of actual reading})$
I:E	150:1-1:150	2:1 ~ 1:4 : $\pm 10\%$ of set value ; Others : $\pm 15\%$ of set value
Oxygen concentration	21%-100%	$\pm (2.5 \text{ vol.}\% + 2.5\% \text{ of actual reading})$
Airway pressure	0-105cmH ₂ O	$\pm (2\text{cmH}_2\text{O} + 4\% \text{ of actual reading})$
I:E	299:1-1:299	
Positive end expiratory pressure	0-100	$\pm (2\text{cmH}_2\text{O} + 4\% \text{ of actual reading})$
Resistance	5 to 300	
Time constant	50-1000	
Closure pressure(P0.1)	-105-5	$\pm 1-25\%$ of the actual reading
Rapid-shallow-breathing index	0-10000	± 10 of actual reading)
Compliance	0.5-100	



Notices:

- When the ventilator is operated beyond the range specified by the manufacture, it may malfunction. Please ensure that the ventilator works under the specified working conditions, so as to maintain stable operation.
- The total system response time of CO₂ concentration is 1 second.
- The total system response time for oxygen concentration is 3 minutes.
- It takes 3 minutes for oxygen concentration to rise from 10% to 90%.

- When the storage condition exceeds the working condition, the storage state turns into the use state and then it should be placed in the standard environment for more than 8 hours.

- When working pressure of the ventilator exceeds the range specified by the manufacturer, performance of the ventilator will be greatly deviated. If the working pressure is too high, the internal sensors may be damaged. Please ensure that working pressure of the ventilator is within the specified range, so as to maintain stable operation.

13.7. CO₂ specifications

Mainstream CO₂ module	
Measuring range: 0-150 mmHg	
Accuracy	(0-40 mmHg) ±2mmHg
	(41-70 mmHg) ±5% of actual reading
	(71-100 mmHg) ±8% of actual reading
	(101-150 mmHg) ±10% of actual reading
Mainstream CO₂ alarm limit specification	
Upper limit of ETCO ₂ : 1mmHg-150mmHg, closed	
Lower limit of EtCO ₂ : closed, 1mmHg-149mmHg	

13.8. Gas line diagram

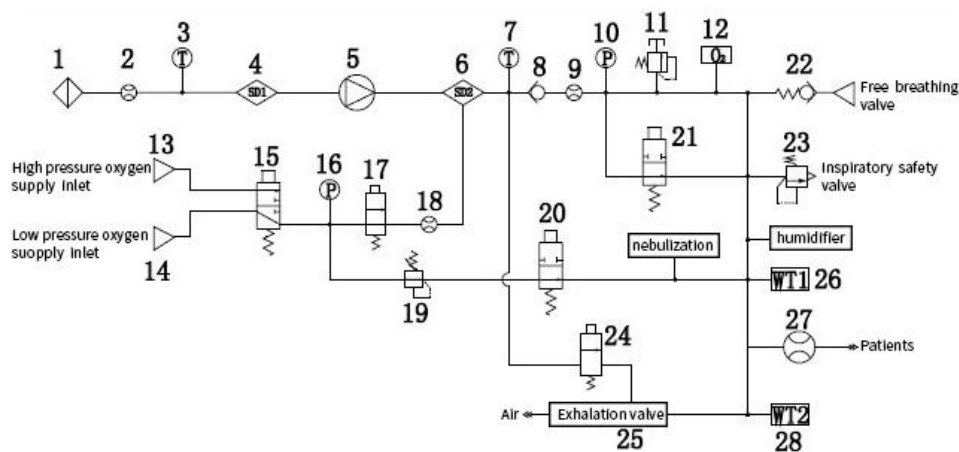

Fig. 13-1 ICV Product Structure Diagram

13.9. Parts list

Symbol	NAME	Symbol	NAME
--------	------	--------	------

1	Air filter cartridge	2	Air inlet flow sensor
3	Temperature sensor	4	Primary acoustic box
5	Turbine	6	Secondary acoustic box
7	Temperature sensor	8	Check valve
9	Fresh gas flow sensor	10	Fresh gas pressure sensor
11	Pressure relief valve	12	Oxygen concentration sensor
13	High pressure oxygen supply inlet	14	Low pressure oxygen supply inlet
15	Oxygen supply control valve	16	Oxygen supply pressure sensor
17	Proportional valve	18	Oxygen flow sensor
19	Pressure relief valve	20	Nebulization control valve
21	Proportional valve	22	Free breathing valve
23	Inspiratory safety valve	24	Proportional valve
25	Exhalation valve	26	Sump tank 1
27	Proximal flow sensor	28	Sump tank 2

13.10.Principle Description

There are two types of oxygen supplies, including high pressure oxygen supply and low pressure oxygen supply: high pressure oxygen is connected via high pressure oxygen inlet 13; and low pressure oxygen is connected via low pressure oxygen inlet 14. Select one oxygen supply type: High pressure oxygen supply or low pressure oxygen supply. The oxygen supply passes through the proportional valve 17, the flow sensor 18, and enters the secondary acoustic mixing box. Another gas circuit passes through the pressure relief valve 19 and nebulization control valve 20, and connects to the nebulization port. The gas is provided to nebulize the patient as required.

The air passes through the air filter 1 and the flow sensor 2, and enter the primary acoustic mixing box; with the action of turbine 5, it's then sucked into the secondary acoustic mixing box 6 to mix with oxygen. The fully mixed gas flows through the check

valve 8 and flow sensor 9, humidified by the humidifier, and then enter the patient's lungs.

The flow rate of the exhaled gas at the patient side is monitored by the flow sensor 27, and flow into the exhalation valve 25, with one end of the valve is connected with the gas circuit. The positive end-expiratory pressure is controlled and adjusted by the proportion valve 24.

When the airway pressure exceeds the limited value of the mainframe, the inspiratory safety valve 23 opens; when the airway pressure exceeds a certain threshold value (11KPa), the pressure relief valve 11 opens and connects with atmosphere.

Oxygen concentration sensor 12 is used to measure the oxygen concentration of gas delivered to the patient. 22 is the free breathing valve. When the main unit fails to provide gas, the patient inhales air through 22.

14. EMC

14.1. Electromagnetic radiation declaration



Caution:

- The ICV ventilator complies with the EMC requirements in Chapter 36 of YY 0505, GB 9706.28, YY 0601 and YY 0600.3.
- Users shall install and use according to the EMC information provided by the accompanying documents.
- Portable and mobile RF communication equipment may affect performance of ICV ventilator, so strong electromagnetic interference shall be avoided during use, such as close to mobile phones, microwave ovens, etc.;
- The guidelines and manufacturer's statements are detailed in the annexes.



Warnings:

- The ICV ventilator shall not be used near or stacked with other devices. If it must be used near or stacked with any other devices then it should be observed to verify that it can operate normally under the configuration used.
- In addition to the cables sold by manufacturer of the ICV Ventilator as spare parts for internal components, use of the accessories and cables other than those specified may result in increased emission or reduced immunity of the ICV ventilator.

Electromagnetic radiation declaration		
The ICV ventilator can be used in following specific electromagnetic environments, and users shall ensure to use the device in following specified electromagnetic environments.		
Radiation test	Compliance test	Electromagnetic environment guidance
Radio-frequency radiation (CISPR 11)	1 set	The ventilator only uses RF energy only when it performs its internal function. Its radio frequency radiation is extremely low, and it is unlikely to cause any electromagnetic interference to nearby electronic equipment.
Radio-frequency radiation (CISPR 11)	Category B	
Harmonic radiation (IEC6100-3-2)	Category A	
Voltage fluctuation and scintillation emission (IEC6100-3-3)	Conform	

14.2. Battery immunity declaration - requirements for all devices and systems

Electromagnetic immunity declaration - requirements for all devices and systems			
The ICV ventilator can be used in following specific electromagnetic environments, and users shall ensure to use the device in following specified electromagnetic environments.			
Immunity category	YY0505 test level	Compliance level	Electromagnetic environment guidance
Electrostatic discharge (ESD) (IEC6100-4-2)	Contact discharge: $\pm 6\text{kV}$ Air discharge: $\pm 8\text{kV}$	Contact discharge: $\pm 8\text{kV}$ Air discharge: $\pm 15\text{kV}$	The floor shall be of wood, concrete or ceramic material. If the floor is paved with composite material, the relative humidity shall be at least 30%.
Electrical fast transient burst (IEC6100-4-4)	For power cord: $\pm 2\text{kV}$ For long I/O cables: $\pm 1\text{kV}$	For power cord: $\pm 2\text{kV}$	The power supply shall have a level that is at least as high as that of a typical commercial or medical environment.
Surge (IEC6100-4-5)	Differential mode: $\pm 1\text{kV}$ Common mode: $\pm 2\text{kV}$	Differential mode: $\pm 1\text{kV}$ Common mode: $\pm 2\text{kV}$	
Power frequency magnetic field (50/60Hz) (IEC6100-4-8)	3A/m	3A/m 50/60Hz	The power frequency magnetic field shall have the level characteristics of power frequency magnetic field at a typical location

			in a typical commercial or medical environment.
Voltage drop, short interruption, and voltage variation (IEC6100-4-11)	< 5%U _T (> 95% drop, U _T), 0.5 cycles;	< 5%U _T (> 95% drop, U _T), 0.5 cycles;	The power supply shall have a level that is at least as high as that of a typical commercial or medical environment. It is recommended to use the uninterruptible power supply, so as to ensure that the product can continue to operate during AC power supply interruption.
	<40%U _T (60% drop, U _T), 5 cycles;	<40%U _T (60% drop, U _T), 5 cycles;	
	70%U _T (30% drop, U _T), 25 cycles; <5% U _T (>95% drop, U _T), 5s;	70%U _T (30% drop, U _T), 25 cycles; <5% U _T (>95% drop, U _T), 5s;	

14.3. Guidelines and manufacturer's statement - electromagnetic immunity

Guidelines and manufacturer's statement - electromagnetic immunity			
The ICV ventilator is intended to be used in the electromagnetic environment specified below and the purchaser or user shall ensure that it is used in this electromagnetic environment.			
Immunity test	IEC 60601 test level	compliance level	Electromagnetic environment guidance
Radio-frequency conduction IEC6100-4-6	3V (effective value)150 kHz-80 MHz(Except ISM frequency band ^{a)})	3V (effective value)	The portable and mobile RF communication devices shall be used at a distance not less than the recommended isolation distance from any part of the ICV ventilator (including cables). The distance is calculated by a formula corresponding to the transmitter frequency. Recommended isolation distance: $d = \left[\frac{3.5}{V1} \right] \sqrt{P}$ $d = \left[\frac{12}{V2} \right] \sqrt{P}$ $d = \left[\frac{12}{E1} \right] \sqrt{P} \quad 80 \text{ MHz} \sim 800 \text{ MHz}$ $d = \left[\frac{23}{E1} \right] \sqrt{P} \quad 800 \text{ MHz} \sim 2.5 \text{ GHz}$ Wherein: —The maximum rated output power of the transmitter provided by the transmitter manufacturer, in watts (W); <i>d</i> - Recommended isolation distance, in meters (m) ^b . The field intensity of a fixed radio frequency transmitter is determined by surveying the electromagnetic field <i>c</i> , but <i>d</i> in each frequency range shall be lower than the compliance level.
Radio-frequency radiation IEC6100-4-3	10V (effective value)150kHz-80 MHz(ISM frequency band ^{a)})	10V (effective value)	
	10V/m80 MHz ~ 2.5 GHz	30V/m	

			<p>Interference may occur near devices marked with the following symbols.</p> 
--	--	--	---

Note 1:

The formula of higher frequency band is used at the 80MHz and 800MHz frequency points.

Note 2:

These guidelines may not be applicable to all situations. Electromagnetic propagation is affected by absorption and reflection from buildings, objects and the human bodies.

^aThe ISM frequency bands between 150kHz and 80MHz are 6.765MHz-6.795MHz, 13.553MHz-13.567MHz, 26.957MHz-27.283MHz and 40.66MHz-40.70MHz.

^bThe compliance levels in the ISM frequency band of 150kHz-80MHz and in the frequency range of 80MHz-2.5GHz are used to reduce the possibility of interference caused by mobile/portable communication devices being accidentally brought into the patient area. For this purpose, an additional factor of 10/3 is used to calculate the recommended isolation distances for transmitters within these frequency ranges.

^c The field intensity of fixed transmitters is theoretically unpredictable, such as base stations for wireless (cellular/cordless) telephones and terrestrial mobile radios, amateur radios, AM and FM radio broadcasts, and television broadcasts. In order to evaluate electromagnetic environment of the fixed radio frequency transmitter, survey of the electromagnetic field shall be taken into consideration. If the measured field intensity at the location of the ICV ventilator is higher than the applicable RF compliance level mentioned above, the ICV ventilator shall be observed to verify its normal operation. If any abnormal performance is observed, supplementary measures may be necessary, for example reorienting or positioning the ICV ventilator.

^d The field intensity in the whole frequency range of 150kHz-80MHz shall be less than 3V/m.

14.4. Recommended isolation distance

Recommended isolation distance between portable and mobile radio frequency communication device and ICV ventilator				
<p>The ICV ventilator is intended to be used in an electromagnetic environment in which the radio frequency radiation disturbance is controlled. The purchaser or user, depending on the maximum rated power output of the communication device, can prevent EMI by maintaining the minimum distance between portable and mobile RF communication device (transmitter) and ICV ventilator as recommended below.</p>				
The maximum rated output power of the transmitter W	Isolation distance for different frequencies of the transmitter/m			
	150kHz-80MHz (Except ISM frequency bands) $d = 1.2\sqrt{P}$	150kHz-80MHz (ISM frequency bands) $d = 1.2\sqrt{P}$	80 MHz - 800 MHz $d = 0.4\sqrt{P}$	800 MHz - 2.5 GHz $d = 0.8\sqrt{P}$
0.01	0.12	0.12	0.04	0.08
0.1	0.38	0.38	0.12	0.24
1	1.2	1.20	0.4	0.8
10	3.8	3.80	1.2	2.4
100	12.00	12.00	3.8	7.7
<p>For the maximum rated output power of the transmitter not listed in the table above, the recommended isolation distance d (in meters (m)) can be determined by the formula in the frequency bar of corresponding transmitter. The P here is the maximum rated output power of the transmitter, in watts (W), provided by the transmitter manufacturer.</p> <p>Note 1: The formula of higher frequency band is used at the 80MHz and 800MHz frequency points.</p> <p>Note 2: The ISM frequency bands between 150kHz and 80MHz are 6.765MHz-6.795MHz, 13.553MHz-13.567MHz, 26.957MHz-27.283MHz and 40.66MHz-40.70MHz.</p> <p>Note 3: The additional factor 10/3 is used to calculate the recommended isolation distance for the transmitter with 150kHz-80MHz ISM frequency band and 80MHz-2.5GHz frequency range, in order to reduce the possibility of interference caused by the fact that the portable/mobile RF communication device is accidentally brought into the</p>				

patient area.

Note 4:

These guidelines may not be applicable to all situations. Electromagnetic propagation is affected by absorption and reflection from buildings, objects and the human bodies.

14.5. Basic EMC performance of ICV ventilator

Basic EMC performance of ICV ventilator	
The ICV ventilator can work normally according to the parameter settings. For details, please see Chapter 11 of the Manual. The alarms can be given according to real-time monitoring on status of the ICV ventilator. Accuracy of following parameters can be ensured in the EMC environment declared for the ICV ventilator:	
Tidal volume	300-2,000ml (adjustable, error: $\pm 0.1S$) or $\pm 10\%$ of set value
Inspiratory time	0.20-10S (adjustable), error: $\pm 0.1S$ or $\pm 10\%$ of set value, whichever is greater
Breath rate	5-40bpm (adjustable), error: ± 1 bpm

15. Product warranty

1 . Gradian Health Systems can carry out free of charge maintenance for the product quality problems occurred during normal use, based on product instructions within two years from the date of purchase. If the warranty period indicated on the product is less than two years, the warranty will expire at the end of the expiration date indicated on the package or in the Operation Manual.

2 . When a warranty is requested, A purchase certificate indicating the seller and the date of purchase must be provided.

3 . Warranty is not covered under the following conditions:

- Violation of the Operation Manual
- Wrong Operation
- Improper use or disposal
- Repair of the device by unauthorized personnel
- Force majeure, e.g. lightning, etc.
- Transport damage caused by improper packing during returned delivery
- No maintenance was done
- Wear caused by overuse, or normal wear. Examples of such components are:
 - Filter
 - Battery
 - Disposable items and so on.
 - The spare parts used are not genuine.

4 . Gradian Health Systems is not responsible for any problems that occur during use of the product after the expiry date of the product.

5 . Gradian Health Systems reserves the right, to eliminate defects, provide non-defective goods or appropriately reduce the purchase price according to its choice.

6 . If the warranty claim is rejected, we do not bear the cost of round-trip transportation.

7 . The statutory warranty requirements are not affected by this.

16. Classification details of toxic and harmful substances



Name and content of toxic and harmful substances or elements							
Part name		Cadmium (Cd)	Mercury (Hg)	Lead (Pb)	Hexavalent chromium Cr(VI)	Polybrominated biphenyls (PBB)	Polybrominated diphenyl ethers (PBDE)
Display screen		x	x	x	x	x	x
Lithium battery		x	x	x	x	x	x
Packing materials		o	x	x	o	x	x
Mainframe	PCBA	o	o	x	o	o	o
	Internal connecting line	o	o	o	o	o	o
	Machined parts	o	o	o	x	o	o
Machine casing	Keys	o	o	o	o	o	o
	Label	o	o	o	o	o	o
	Front cover	o	o	o	o	o	o
	Rear cover	o	o	o	o	o	o
Accessories	Oxygen pipe	o	o	o	o	o	o
	Mask	o	o	o	o	o	o
	Oxygen source hose assembly	o	o	o	o	o	o
	Gas pocket	o	o	o	o	o	o
	Power cord	o	o	o	o	o	o
	Connector	o	o	o	x	o	o
	Flow sensor	o	o	o	o	o	o
	Oxygen sensor	o	o	x	o	o	o
CO ₂ monitor	o	o	x	o	o	o	

x: It means that content of the harmful substance or element in at least one homogeneous material of the component exceeds the limit requirements specified in SJ/T11363-2006.

o: It means that at least content of the harmful substance or element in all the homogeneous materials of the component is within the limit requirements specified in SJ/T11363-2006.

17. Storage and transportation

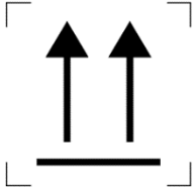
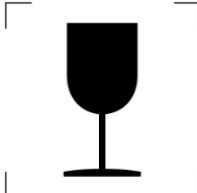
The pack products are allowed to be transported by road, air or rail. Shock and violent vibration shall be prevented during transportation. See the description in the table below:

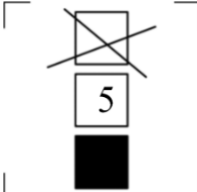
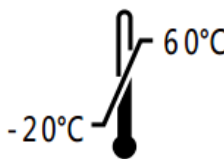
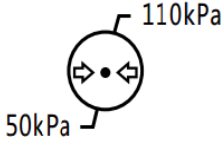
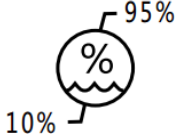
Graphic symbols	Description	Graphic symbols	Description
	This side up		Handle with care
	Keep dry		Stacking layer limit: 5
	Temperature limit: - 20°C-60°C		
	Pressure range: 50KPa-110KPa		
	Humidity range: 10%-95% (non- condensation)		

Warning:

When the storage conditions exceed the requirements of the working environment, it shall be placed in the standard environment for more than 8 hours before it can be used when it is changed from storage state to operating state.



Gradian Health Systems

Address: 40 W 25th St., 6th Floor, New York, NY 10010, USA

Tel: +1 917 396 7030

Website: www.gradianhealth.org